

JVC

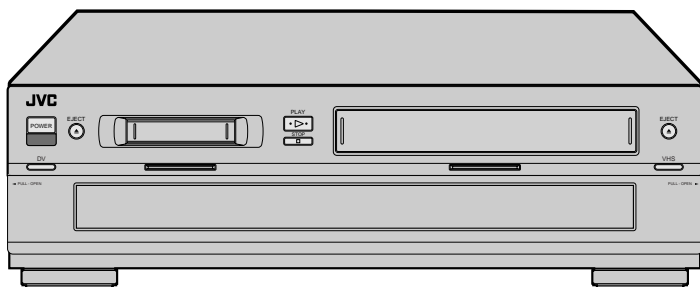

Mini DV/S-VHS
VIDEO CASSETTE RECORDER

HR-DVS1U



SVHS

Mini **DV**

Hi-Fi

VCRplus+®
CABLE BOX
CONTROL

Super VHS ET

INSTRUCTIONS

For Customer Use:

Enter below the Model No. and Serial No. which are located on the rear of cabinet. Retain this information for future reference.

Model No. _____

Serial No. _____

Dear Customer,

Thank you for purchasing the JVC VHS video cassette recorder. Before use, please read the safety information and precautions contained in the following pages to ensure safe use of your new VCR.

CAUTIONS

The lightning flash with arrowhead symbol, within an equilateral triangle, is intended to alert the user to the presence of uninsulated "dangerous voltage" within the product's enclosure that may be of sufficient magnitude to constitute a risk of electric shock to persons.



The exclamation point within an equilateral triangle is intended to alert the user to the presence of important operating and maintenance (servicing) instructions in the literature accompanying the appliance.

WARNING:
TO PREVENT FIRE OR SHOCK HAZARD, DO NOT EXPOSE THIS UNIT TO RAIN OR MOISTURE.

CAUTION:

This video cassette recorder should be used with AC 120V~, 60Hz only. To prevent electric shocks and fire hazards, DO NOT use any other power source.

CAUTION:

TO PREVENT ELECTRIC SHOCK, MATCH WIDE BLADE OF PLUG TO WIDE SLOT, FULLY INSERT.

ATTENTION:

POUR ÉVITER LES CHOCS ÉLECTRIQUES, INTRODUIRE LA LAME LA PLUS LARGE DE LA FICHE DANS LA BORNE CORRESPONDANTE DE LA PRISE ET POUSSER JUSQU'AU FOND.

Note to CATV system installer:

This reminder is provided to call the CATV system installer's attention to Article 820-40 of the NEC that provides guidelines for proper grounding and, in particular, specifies that the cable ground shall be connected to the grounding system of the building, as close to the point of cable entry as practical.

CAUTION:

Changes or modifications not approved by JVC could void user's authority to operate the equipment.

Failure to heed the following precautions may result in damage to the VCR, remote control or video cassette.

- DO NOT** place the VCR . . .
 - ... in an environment prone to extreme temperatures or humidity.
 - ... in direct sunlight.
 - ... in a dusty environment.
 - ... in an environment where strong magnetic fields are generated.
 - ... on a surface that is unstable or subject to vibration.
- DO NOT** block the VCR's ventilation openings.
- DO NOT** place heavy objects on the VCR or remote control.
- DO NOT** place anything which might spill on top of the VCR or remote control.
- AVOID** violent shocks to the VCR during transport.

****MOISTURE CONDENSATION**

Moisture in the air will condense on the VCR when you move it from a cold place to a warm place, or under extremely humid conditions—just as water droplets form on the surface of a glass filled with cold liquid. Moisture condensation on the head drum will cause damage to the tape. In conditions where condensation may occur, keep the VCR's power turned on for a few hours to let the moisture dry before inserting a tape.

****ABOUT HEAD CLEANING**

Accumulation of dirt and other particles on the video heads may cause the playback picture to become blurred or interrupted. Be sure to contact your nearest JVC dealer if such troubles occur.

VCR Plus+ C³ and PlusCode are registered trademarks of Gemstar Development Corporation. The VCR Plus+ system is manufactured under license from Gemstar Development Corporation.

DSS™ is an official trademark of DIRECTV, Inc., a unit of GM Hughes Electronics. PRIMESTAR is a registered service mark of Primestar Partners, L.P. DISH Network™ is a trademark of EchoStar Communications Corporation.



- Cassettes marked "S-VHS" and "VHS" can be used with this video cassette recorder. However, S-VHS recordings are possible only with cassettes marked "S-VHS". By using S-VHS ET it is possible to record and play back with S-VHS picture quality on VHS cassettes with this VCR.
- Cassettes marked "Mini DV" can be used with the DV deck of this VCR. The DV deck can play back and record only NTSC signals.

This product incorporates copyright protection technology that is protected by method claims of certain U.S. patents and other intellectual property rights owned by Macrovision Corporation and other rights owners. Use of this copyright protection technology must be authorized by Macrovision Corporation, and is intended for home and other limited viewing users only unless otherwise authorized by Macrovision Corporation. Reverse engineering or disassembly is prohibited.

IMPORTANT PRODUCT SAFETY INSTRUCTIONS

Electrical energy can perform many useful functions. But improper use can result in potential electrical shock or fire hazards. This product has been engineered and manufactured to assure your personal safety. In order not to defeat the built-in safeguards, observe the following basic rules for its installation, use and servicing.

ATTENTION:

Follow and obey all warnings and instructions marked on your product and its operating instructions. For your safety, please read all the safety and operating instructions before you operate this product and keep this booklet for future reference.

INSTALLATION

1. Grounding or Polarization

(A) Your product may be equipped with a polarized alternating-current line plug (a plug having one blade wider than the other). This plug will fit into the power outlet only one way. This is a safety feature.

If you are unable to insert the plug fully into the outlet, try reversing the plug. If the plug should still fail to fit, contact your electrician to replace your obsolete outlet. Do not defeat the safety purpose of the polarized plug.

(B) Your product may be equipped with a 3-wire grounding-type plug, a plug having a third (grounding) pin. This plug will only fit into a grounding-type power outlet. This is a safety feature.

If you are unable to insert the plug into the outlet, contact your electrician to replace your obsolete outlet. Do not defeat the safety purpose of the grounding-type plug.

2. Power Sources

Operate your product only from the type of power source indicated on the marking label. If you are not sure of the type of power supply to your home, consult your product dealer or local power company. If your product is intended to operate from battery power, or other sources, refer to the operating instructions.

3. Overloading

Do not overload wall outlets, extension cords, or integral convenience receptacles as this can result in a risk of fire or electric shock.

4. Power Cord Protection

Power supply cords should be routed so that they are not likely to be walked on or pinched by items placed upon or against them, paying particular attention to cords at plugs, convenience receptacles, and the point where they exit from the product.

5. Ventilation

Slots and openings in the cabinet are provided for ventilation. To ensure reliable operation of the product and to protect it from overheating, these openings must not be blocked or covered.

- Do not block the openings by placing the product on a bed, sofa, rug or other similar surface.
- Do not place the product in a built-in installation such as a bookcase or rack unless proper ventilation is provided or the manufacturer's instructions have been adhered to.

6. Wall or Ceiling Mounting

The product should be mounted to a wall or ceiling only as recommended by the manufacturer.

ANTENNA INSTALLATION INSTRUCTIONS

1. Outdoor Antenna Grounding

If an outside antenna or cable system is connected to the product, be sure the antenna or cable system is grounded so as to provide some protection against voltage surges and built-up static charges. Article 810 of the National Electrical Code, ANSI/NFPA 70, provides information with regard to proper grounding of the mast and supporting structure, grounding of the lead-in wire to an antenna discharge unit, size of grounding connectors, location of antenna discharge unit, connection to grounding electrodes, and requirements for the grounding electrode.

2. Lightning

For added protection for this product during a lightning storm, or when it is left unattended and unused for long periods of time, unplug it from the wall outlet and disconnect the antenna or cable system. This will prevent damage to the product due to lightning and power-line surges.

3. Power Lines

An outside antenna system should not be located in the vicinity of overhead power lines or other electric light or power circuits, or where it can fall into such power lines or circuits. When installing an outside antenna system, extreme care should be taken to keep from touching such power lines or circuits as contact with them might be fatal.

EXAMPLE OF ANTENNA GROUNDING AS PER NATIONAL ELECTRICAL CODE, ANSI/NFPA 70

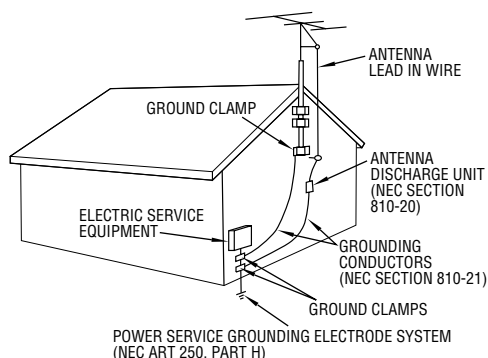

NEC – NATIONAL ELECTRICAL CODE

USE

1. Accessories

To avoid personal injury:

- Do not place this product on an unstable cart, stand, tripod, bracket, or table. It may fall, causing serious injury to a child or adult, and serious damage to the product.
- Use only with a cart, stand, tripod, bracket, or table recommended by the manufacturer or sold with the product.
- Use a mounting accessory recommended by the manufacturer and follow the manufacturer's instructions for any mounting of the product.
- Do not try to roll a cart with small casters across thresholds or deep-pile carpets.

2. Product and Cart Combination

A product and cart combination should be moved with care. Quick stops, excessive force, and uneven surfaces may cause the product and cart combination to overturn.

PORTABLE CART WARNING
(Symbol provided by RETAC)



3. Water and Moisture

Do not use this product near water—for example, near a bath tub, wash bowl, kitchen sink or laundry tub, in a wet basement, or near a swimming pool and the like.

4. Object and Liquid Entry

Never push objects of any kind into this product through openings as they may touch dangerous voltage points or short-out parts that could result in a fire or electric shock. Never spill liquid of any kind on the product.

5. Attachments

Do not use attachments not recommended by the manufacturer of this product as they may cause hazards.

6. Cleaning

Unplug this product from the wall outlet before cleaning. Do not use liquid cleaners or aerosol cleaners. Use a damp cloth for cleaning.

7. Heat

The product should be situated away from heat sources such as radiators, heat registers, stoves, or other products (including amplifiers) that produce heat.

SERVICING

1. Servicing

If your product is not operating correctly or exhibits a marked change in performance and you are unable to restore normal operation by following the detailed procedure in its operating instructions, do not attempt to service it yourself as opening or removing covers may expose you to dangerous voltage or other hazards. Refer all servicing to qualified service personnel.

2. Damage Requiring Service

Unplug this product from the wall outlet and refer servicing to qualified service personnel under the following conditions:

- a. When the power supply cord or plug is damaged.
- b. If liquid has been spilled, or objects have fallen into the product.
- c. If the product has been exposed to rain or water.
- d. If the product does not operate normally by following the operating instructions. Adjust only those controls that are covered by the operating instructions as an improper adjustment of other controls may result in damage and will often require extensive work by a qualified technician to restore the product to its normal operation.
- e. If the product has been dropped or damaged in any way.
- f. When the product exhibits a distinct change in performance—this indicates a need for service.

3. Replacement Parts

When replacement parts are required, be sure the service technician has used replacement parts specified by the manufacturer or have the same characteristics as the original part. Unauthorized substitutions may result in fire, electric shock or other hazards.

4. Safety Check

Upon completion of any service or repairs to this product, ask the service technician to perform safety checks to determine that the product is in safe operating condition.

HOW TO USE THIS INSTRUCTION MANUAL

- All major sections and subsections are listed in the Table Of Contents on page 5. Use this when searching for information on a specific procedure or feature.
- The Index on pages 74 – 78 lists frequently-used terms, and the number of the page on which they are used or explained in the manual. This section also illustrates the controls and connections on the front and rear panel, the front display panel and the remote control.
- The  mark signals a reference to another page for instructions or related information.
- Operation buttons necessary for the various procedures are clearly indicated through the use of illustrations at the beginning of each major section.

BEFORE YOU INSTALL YOUR NEW VCR . . .

. . . please read the sections/literature listed below.

- "Cautions" on page 2
- "Important Product Safety Instructions" on the previous pages

I	NSSTALLING YOUR NEW VCR	6
C	onnections	6
	Basic Connections	6
	S-VIDEO Connection	7
	Component Video Connection	7
I	NITIAL SETTINGS	8
P	lug & Play	8
L	anguage	9
C	lock	10
	Preparation	10
	Semi-Auto	11
	Manual	12
T	uner	13
	Set Receivable Channels	13
	Add Or Delete A Channel	14
C	able Box Control	15
	Situate And Connect Controller	15
	Set Cable Box Output Channel & Cable Box Brand	16
D	BS Receiver Control	18
	Situate And Connect Controller	18
	Set DBS Receiver Output Channel & DBS Receiver Brand	19
S	IMPLE PLAYBACK AND RECORDING	21
	Simple Playback	21
	Simple Recording	22
P	LAYBACK AND RECORDING FEATURES	23
P	layback Features	23
	High-Speed Search	23
	Still Picture/Frame-By-Frame Playback	23
	Slow Motion/Reverse Slow Motion/Reverse Motion Playback	23
	High-Speed Search (On the Remote Control)	24
	Variable-Speed Search/Reverse Motion Playback (On the Remote Control)	24
	Still Picture/Frame-By-Frame Playback (On the Remote Control)	24
	Slow Motion/Reverse Slow Motion (On the Remote Control)	24
	Superimpose	25
	Manual Tracking	26
	Index Search	26
	Repeat Playback	27
	Counter Reset	27
	Next-Function Memory	27
	Display Mode Setting	27
	Tape Position Indicator	27
	Time Code	27
	Picture Control	28
	Video Stabilizer	29
	Select The Soundtrack (VHS deck)	29
	Digital TBC/NR	30
	Digital R ³	31
	Zoom	32
	Playback Effect	32
	Select The Soundtrack (DV deck)	33
	Sound Mode Selection	33
	32kHz Mode Setting	33
A	ctive Video Calibration	34
	Preparation	34
	Playback	35
	Recording	35
R	ecording Features	36
	Record One Program While Watching Another	36
	Display Elapsed Recording Time	36
	Display Tape Remaining Time	36

	Stereo And SAP (Second Audio Program)	37
	To Record SAP Programs	37
	Retake	37
	S-VHS (Super VHS), S-VHS ET and VHS	38
	Super VHS ET	39

T **IMER RECORDING** **40**

VCR Plus+® Timer Programming	40
Changing VCR Plus+® Setting	42
Express Timer Programming	44
Check, Cancel And Revise Programs	46
Auto SP→EP Timer	47
Auto Timer	48
Instant Timer Recording (ITR)	49

E **DITING** **50**

Tape Dubbing	50
Normal Dubbing	51
Random Assemble Editing	52
Fader and Wipe Menu	55
Edit From A Camcorder	56
Edit To Or From Another VCR	58
Audio Dubbing	60
Insert Editing	62

S **YSTEM CONNECTIONS** **64**

Connecting To A Video Titler	64
Connecting To A Printer	65

S **PECIAL FEATURES** **66**

TV Multi-Brand Remote Control	66
Cable Box Multi-Brand Remote Control	67
DBS Receiver Multi-Brand Remote Control	68
Control Two JVC VCRs	69

T **ROUBLESHOOTING** **70**

Power	70
Tape Transport	70
Playback	70
Recording	70
Timer Recording	71
Other Problems	72

Q **UESTIONS AND ANSWERS** **73**

Playback	73
Recording	73
Timer Recording	73

I **NDEX** **74**

Front View	74
Rear View	75
VHS Display Panel	76
DV Display Panel	76
Remote Control	77
List Of Terms	78

S **PECIFICATIONS** **79**

F **OR SERVICING** **80**

W **ARRANTY** **81**

Connections

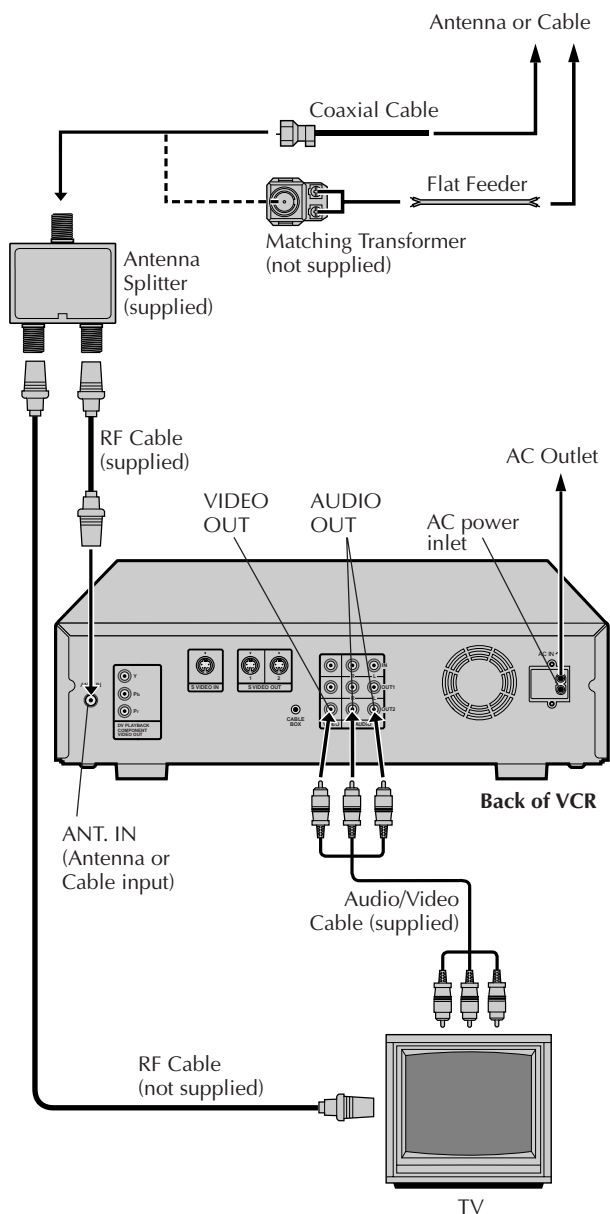

NOTES:

- For full identification of the VCR's rear panel, refer to the Index (REAR VIEW ☞ pg. 75).
- It is not possible to view a TV program through the VCR by the ordinary RF connection.

Basic Connections

1 CHECK CONTENTS

Make sure the package contains all of the accessories listed in "SPECIFICATIONS" (☞ pg. 79).

2 SITUATE VCR

Place the VCR on a stable, horizontal surface.

3 CONNECT VCR TO TV

The connection method you use depends on the type of TV you have.

- Disconnect the TV antenna from the TV.
- Connect the TV antenna cable to the ANT. IN jack on the rear of the VCR, using the antenna splitter.
- Connect the RF cable between the antenna splitter and the TV's antenna terminal.
- Connect an Audio/Video Cable between the AUDIO OUT and VIDEO OUT jacks on the rear of the VCR and the AV IN jacks on the TV. Set your TV in video input mode or A/V input mode. Refer to the TV Instruction Manual.

S-VIDEO Connection

- If you have a TV with S-VIDEO input terminals, see "S-VIDEO Connection" on page 7.

Component Video Connection

- If you have a TV with component video input terminals, see "Component Video Connection" on page 7.

4 CONNECT VCR TO POWER SOURCE

Connect the provided AC power cord to the AC power inlet on the rear of the VCR first, then to an AC outlet.

- The clock and tuner channels will automatically be set when the antenna is connected and when the AC is first connected to the VCR (☞ pg. 8). (If "Auto" or "CH" is displayed on the front display panel before the VCR is powered on, the clock and tuner channels are being set automatically. Wait for the time to be displayed on the front display panel before powering on the VCR.)

5 FINAL PREPARATION FOR USE

Power on the VCR. You can now perform simple playback (☞ pg. 21) or simple recording (☞ pg. 22).

S-VIDEO Connection

CONNECT VCR TO TV

- Connect both the RF cable and the AV cables to the TV as explained in step 3 of "Basic Connections" (pg. 6).
- Connect the S-Video cable between the S-VIDEO OUT jack on the rear of the VCR and the S-VIDEO IN jack on the TV.

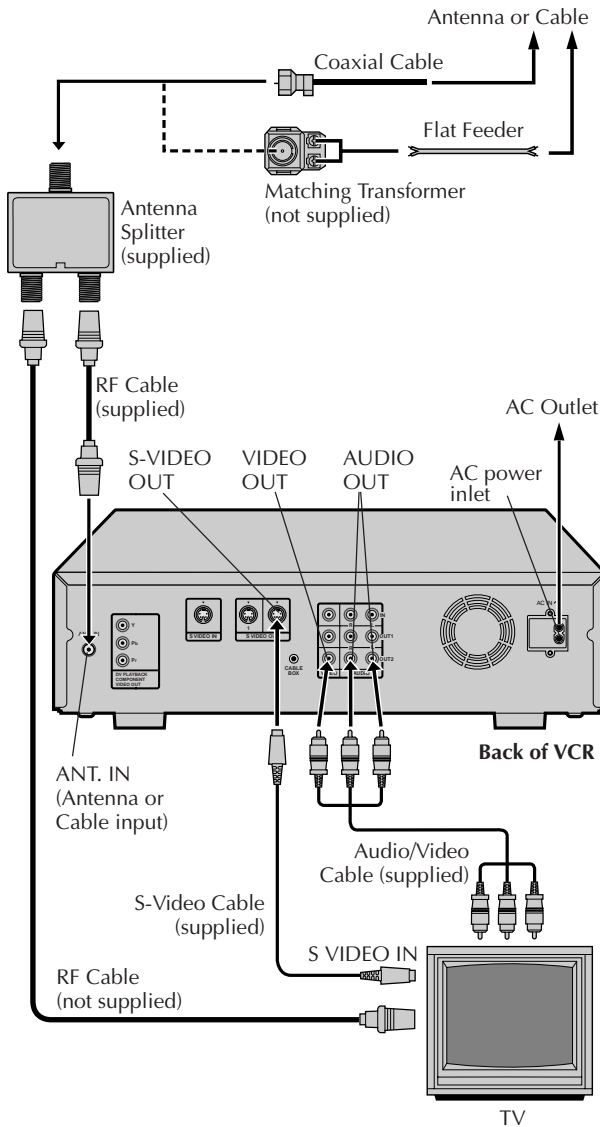

Component Video Connection

CONNECT VCR TO TV

- Connect both the RF cable and the AV cables to the TV as explained in step 3 of "Basic Connections" (pg. 6).
- Connect the component video cables between the DV PLAYBACK COMPONENT VIDEO OUT jacks on the rear of the VCR and the component video input jacks on the TV.

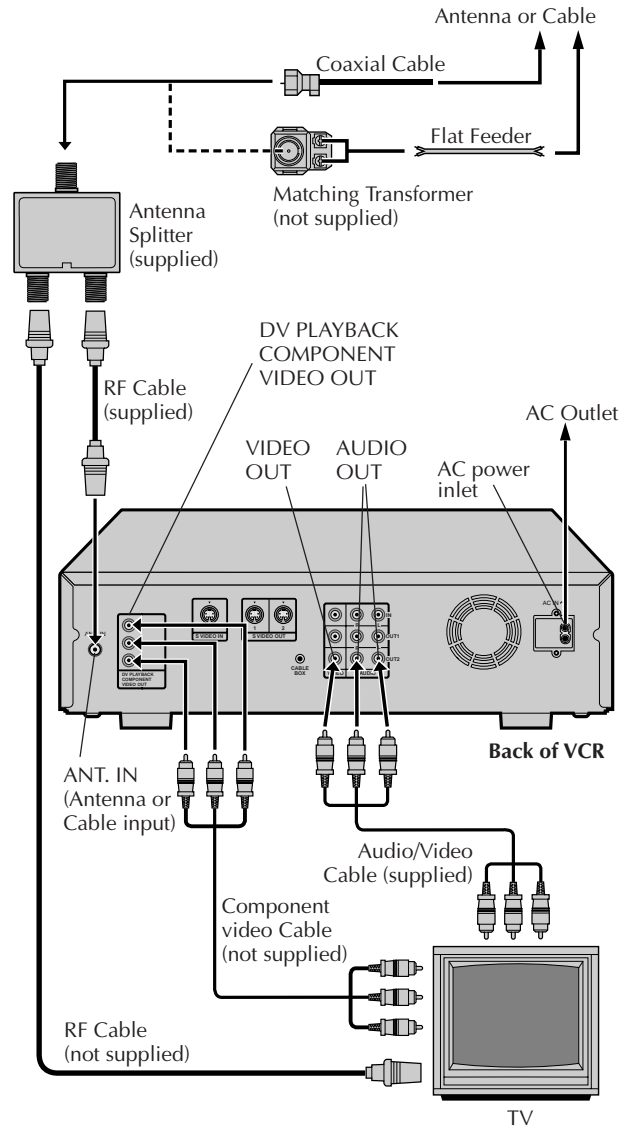

NOTES:

- To make the most of the Super VHS picture performance we recommend that you use the supplied S-VIDEO cable to connect your VCR to a TV with an S-VIDEO input connector.
- To operate the VCR with your TV using the S-VIDEO connection, set your TV to the AV mode using the TV's remote control. You can also use the TV/VCR button on the VCR's remote control to set your TV to the AV mode. (pg. 66)

NOTES:

- The menu screens of the VCR are not displayed on the TV.
- To change the settings or set the timer program on the menu screen, switch the TV's input mode for the connection with Audio/Video cables.

Plug & Play

Auto Clock Set/Auto Tuner Set

ATTENTION

If you use a cable box, Plug & Play will not function; set the clock and tuner channels manually. (☞ pg.10 – 14)

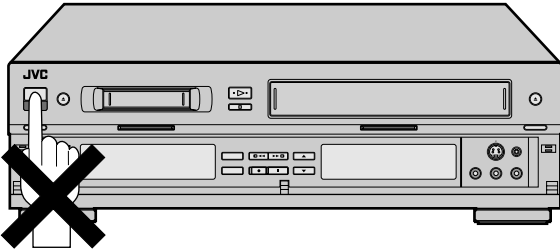

IMPORTANT

- Don't press any buttons on the VCR or remote while Plug & Play is in progress.
- If you perform Plug & Play successfully, there's no need to perform the Clock (☞ pg. 10) and Tuner (☞ pg. 13) procedures. If, however, you want to add or delete channels, refer to "Add Or Delete A Channel" on page 14.

The Plug & Play function sets the clock and tuner channels automatically when power is first connected to the VCR. The antenna cable must be connected for the Plug & Play function.

The time and date can be set automatically from clock setting data that is transmitted by one of the regular TV broadcast channels. We call this TV channel the "Host Channel" and it is a PBS channel in your area.

1 PLUG & PLAY SETUP

1 Connect the antenna cable to the VCR (☞ pg. 6). Then connect the VCR's power plug to an AC outlet. Do not power on the VCR. The clock and tuner channels will be set automatically.

NOTES:

- Auto clock set is performed first. The auto clock set function scans all the channels received by your VCR to find the Host Channel and then sets the clock. "Auto" blinks on the front display panel during Auto clock set.
- Auto channel set is performed next. The auto channel set function scans all the channels that are receivable by your VCR. It then automatically assigns each receivable channels to the CH▲▼ (+/-) buttons. It skips non-receivable channels. During auto channel set the channel numbers are displayed as they are scanned and set.
- When Plug & Play has been completed successfully the correct time is displayed.
- If an incorrect time or "- :- -" appears on the display panel, see "What To Do If Plug & Play Has Failed" below.

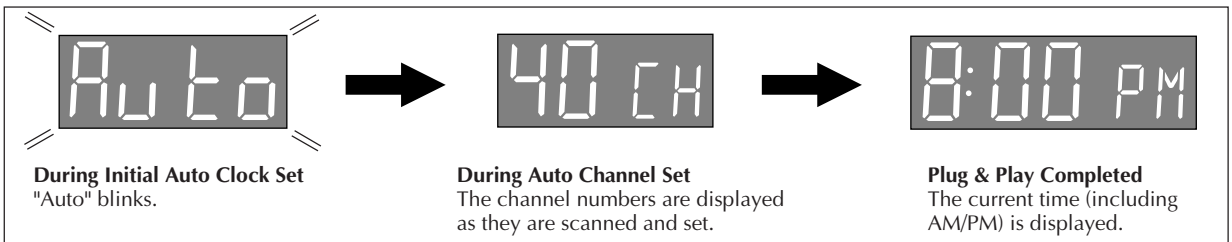

* If an incorrect time or "- :- -" appears on the display panel, see "What To Do If Plug & Play Has Failed" below.

INFORMATION

- If "AUTO CLOCK" is set to "ON" at the Clock Set screen on page 11, the clock will be adjusted automatically by the host channel every hour on the hour (except for 11:00 PM, midnight, 1:00 AM and 2:00 AM) by the incoming PBS channel clock setting data. (This automatic clock adjustment can only be performed when the VCR's power is turned off. The clock will be adjusted on the hour based on the time displayed on the VCR, not on the actual real time.) The default setting of "AUTO CLOCK" is "ON".
- If the memory backup fails, because of a power outage or because the AC was removed from the VCR, Plug & Play will be performed when power is restored to the VCR.

What To Do If Plug & Play Has Failed

- If an incorrect time is displayed on the front display panel, you may be receiving the clock setting data of a PBS channel from an adjacent time zone, or an incorrect PBS channel from a cable TV system. In this case, perform the Semi-Auto (☞ pg. 11) or Manual Clock Set (☞ pg. 12) procedure. Auto channel set has already taken place and it need not be set again.
- If "- :- -" appears on the display, your antenna cable may not be connected to the VCR or there may not be a Host PBS signal available in your area. Ensure that the antenna cable is connected correctly. Then power on and power off the VCR; the Plug & Play function will be automatically reactivated and "Auto" will be displayed on the VCR's front panel. If Plug & Play is not performed but the antenna cable is connected correctly, perform the Manual Clock Set procedure (☞ pg. 12). Auto channel set has not yet taken place, so please also perform the "Set Receivable Channels" procedure (☞ pg. 13).

Language

Turn on the TV and select the AV mode.

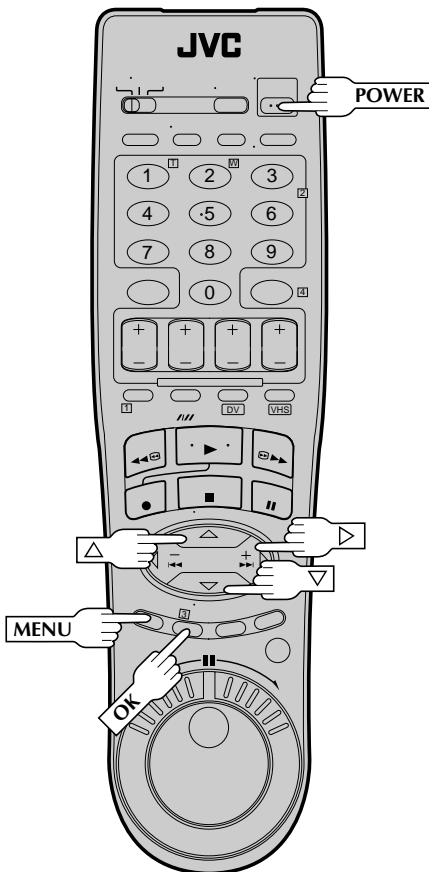
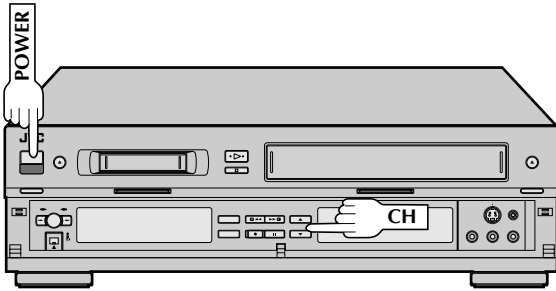

This VCR offers you the choice to view on-screen messages in English, Spanish or French (not including messages superimposed on the TV picture). Select the desired language using this procedure. The default setting is "ENGLISH".

1 TURN ON THE VCR

Press **POWER**.

2 ACCESS MAIN MENU SCREEN

Press **MENU**.

3 ACCESS INITIAL SET SCREEN

At the Main Menu screen, move the highlight bar (arrow) to "INITIAL SET" by pressing **CH▲▼** or **△▽**, then press **OK** or **▷**.

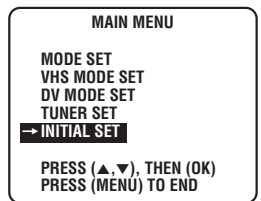

4 SELECT LANGUAGE

Move the highlight bar (arrow) to "LANGUAGE" by pressing **CH▲▼** or **△▽**, then press **OK** or **▷** to select the desired language.

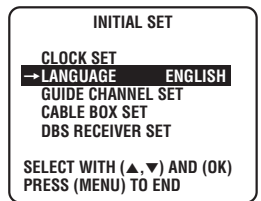

5 RETURN TO NORMAL SCREEN

Press **MENU**.

Clock

Turn on the TV and select the AV mode.

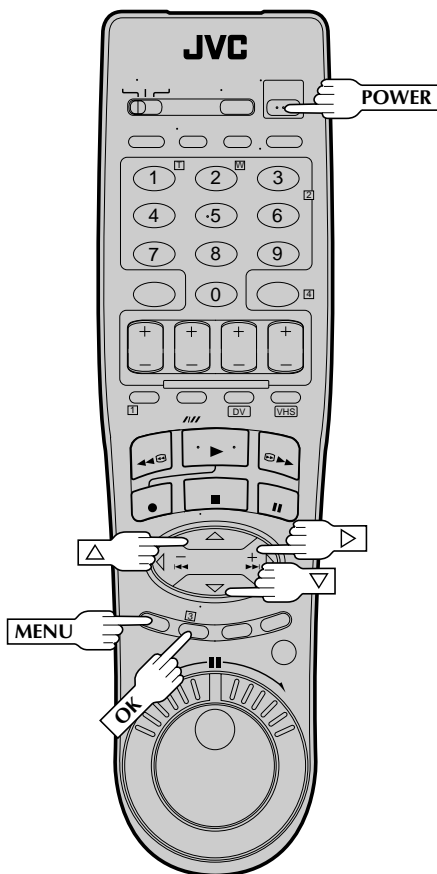
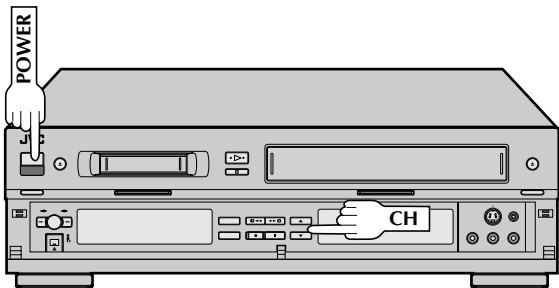

Perform clock setting only if the clock has not been set correctly by the Plug & Play function or you use a cable box. Access the Clock Set screen to perform the Semi-Auto or Manual clock setting procedure. Each procedure starts from step 5. If you use a cable box, set the clock manually. (pg. 12)

Preparation

1 TURN ON THE VCR

Press **POWER**.

2 ACCESS MAIN MENU SCREEN

Press **MENU**.

3 ACCESS INITIAL SET SCREEN

At the Main Menu screen, move the highlight bar (arrow) to "INITIAL SET" by pressing **CH▲▼** or **▲▼**, then press **OK** or **▷**.

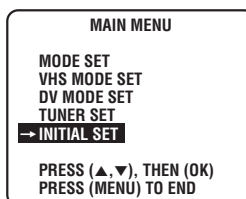

4 ACCESS CLOCK SET SCREEN

Move the highlight bar (arrow) at the Initial Set screen to "CLOCK SET" by pressing **▲▼**, then press **OK** or **▷**.

- "CABLE BOX USERS SET CLOCK MANUALLY" appears on the screen for about 5 seconds, then the Clock Set screen appears.

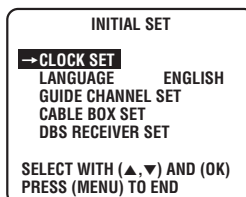

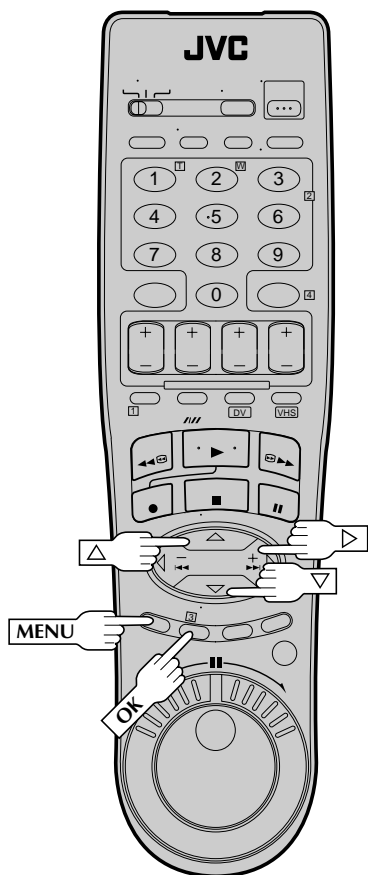
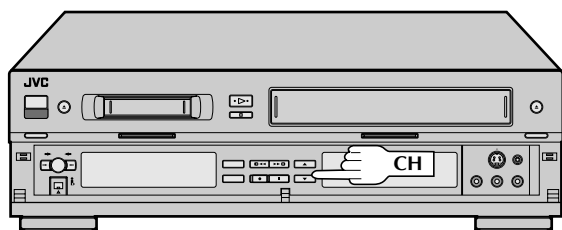

Semi-Auto

You can change the Host Channel/D.S.T. /Time Zone setting manually.

5

SET AUTO CLOCK TO ON

At the Clock Set screen, press **OK** or **▷** repeatedly to move the highlight bar to "AUTO CLOCK" and press **CH ▲▼** or **△▽** to set to "ON".

- To select the Host Channel — go to step 6
- To select the D.S.T. mode — go to step 7
- To select the Time Zone — go to step 8

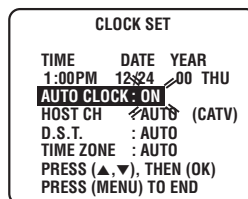

NOTE:

The time that has been set previously will be erased when "AUTO CLOCK", "HOST CH", "D.S.T." or "TIME ZONE" setting is changed.

6

SELECT HOST CHANNEL

You can either select "AUTO" or enter a PBS channel number. Move the highlight bar to "HOST CH" by pressing **OK** or **▷**, then press **CH ▲▼** or **△▽** to set to "AUTO" or the desired PBS channel number.

NOTE:

There are some PBS channels that do not transmit clock setting data.

7

SELECT D.S.T. MODE

You have three choices:

- Select "AUTO" and the adjustment to your VCR's clock will be made according to the incoming signal from the host channel.
- Select "ON" and the adjustment will be made based on the clock itself.
- Select "OFF" if Daylight Saving Time does not apply to you.

Move the highlight bar to "D.S.T." by pressing **OK** or **▷**, then press **CH ▲▼** or **△▽** to select the desired mode.

**AUTO DAYLIGHT SAVING TIME

This function enables automatic adjustment of the VCR's clock at the start and end of Daylight Saving Time.

With Auto DST activated, . . .

. . . on the first Sunday of April at 2:00 AM, the clock is adjusted to 3:00 AM.

. . . on the last Sunday of October at 2:00 AM, the clock is adjusted to 1:00 AM.

8

SELECT TIME ZONE

You can select the time zone automatically or manually. Move the highlight bar to "TIME ZONE" by pressing **OK** or **▷**, then press **CH ▲▼** or **△▽** to select "AUTO" or the desired time zone.

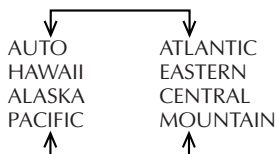

NOTE:

If an incorrect time is displayed by the Plug & Play function, you may be receiving the clock setting data of a PBS channel from an adjacent time zone or from an incorrect PBS channel from a cable TV system. If you selected "AUTO" for the host channel in step 6, be sure to select the correct time zone manually.

RETURN TO NORMAL SCREEN

9

Press **MENU**.

IMPORTANT

Turn the VCR off after performing the Semi-Auto Clock Set procedure. "Auto" will appear on the front display panel when the clock is being set. The current time will appear automatically when the clock is set.

Manual

5

SET TIME

Press **CH ▲▼** or **△▽** until the desired time appears, then press **OK** or **▷**.

- Press and hold **CH ▲▼** or **△▽** to change the time by 30-minute increments.
- When the time is entered manually, "AUTO CLOCK" will be automatically set to "OFF", and "HOST CH" and "TIME ZONE" will disappear.

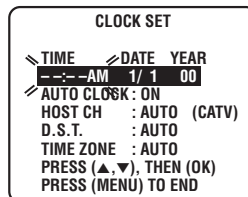

6

SET DATE

Press **CH ▲▼** or **△▽** until the desired date appears, then press **OK** or **▷**.

- Press and hold **CH ▲▼** or **△▽** to change the date by 15-day increments.

7

SET YEAR

Press **CH ▲▼** or **△▽** until the desired year appears, then press **OK** or **▷** twice.

8

SELECT D.S.T. MODE

Press **CH ▲▼** or **△▽** to select the desired mode.

- Set to "ON" so that the adjustment to your VCR's clock will be made on the clock itself.
- Set to "OFF" if Daylight Saving Time does not apply to you.

9

START CLOCK

Press **MENU** and normal screen appears.

To Make Corrections

Press **OK** or **▷** until the item you want to change blinks, then press **CH ▲▼** or **△▽**.

Tuner

Turn on the TV and select the AV mode.

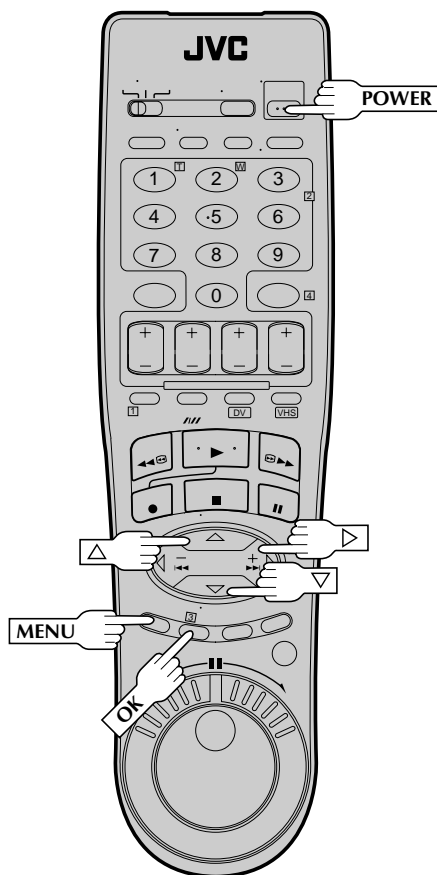
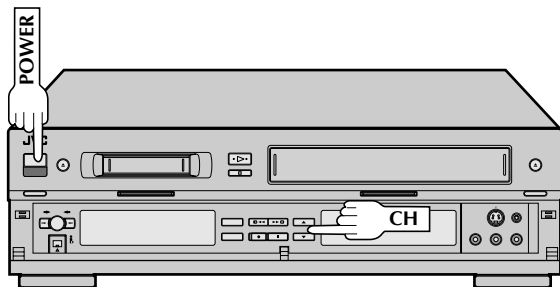

INFORMATION

The VCR detects the band (TV or CATV) and selects the correct band automatically during Auto Channel Set. The selected band will be displayed on the right side of "BAND" on the Tuner Set screen.

Set Receivable Channels

1 TURN ON THE VCR

Press **POWER**.

2 ACCESS MAIN MENU SCREEN

Press **MENU**.

3 ACCESS TUNER SET SCREEN

Move the highlight bar (arrow) to "TUNER SET" by pressing **CH▲▼** or **▲▼**, then press **OK** or **▷**.

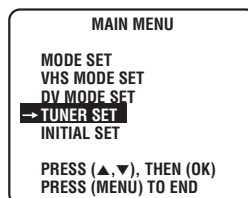

4 PERFORM AUTO CHANNEL SET

Move the highlight bar (arrow) to "AUTO CHANNEL SET" by pressing **CH▲▼** or **▲▼**, then press **OK** or **▷**.

- Receivable channels in your area are automatically assigned to the **CH▲▼** (+/-) buttons, and non-receivable channels are skipped.

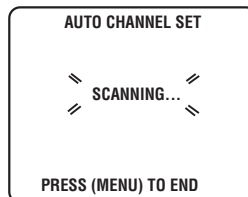
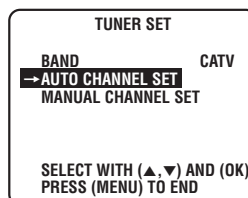

NOTES:

- At the end of Auto Channel Set, "SCAN COMPLETED" appears on screen.
- If the scan was unsuccessful, "SCAN COMPLETED-NO SIGNAL" appears on screen. Check the connections and start again.

5 RETURN TO NORMAL SCREEN

Press **MENU**.

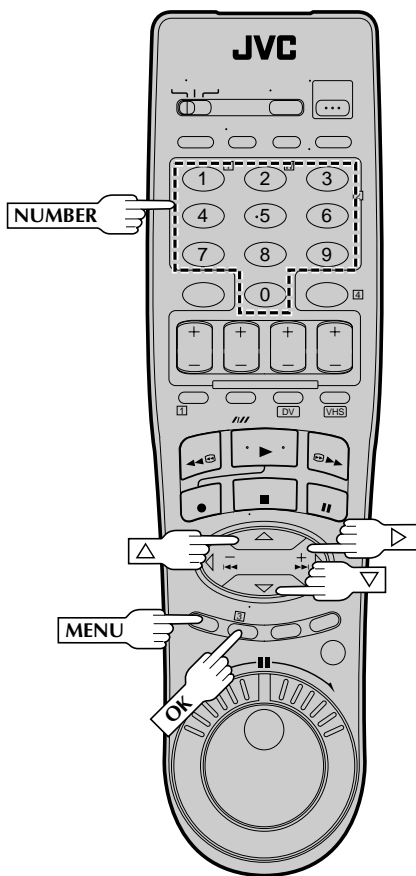
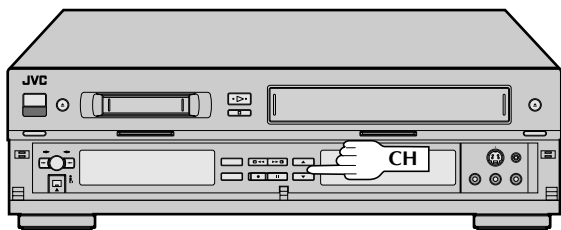

Add Or Delete A Channel

1

ACCESS MAIN MENU SCREEN

Press **MENU**.

2

ACCESS TUNER SET SCREEN

Move the highlight bar (arrow) to "TUNER SET" by pressing **CH▲▼** or **▲▼**, then press **OK** or **▷**.

3

ACCESS MANUAL CHANNEL SET SCREEN

Move the highlight bar (arrow) to "MANUAL CHANNEL SET" by pressing **CH▲▼** or **▲▼**, then press **OK** or **▷**.

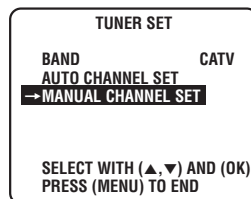

4

ADD OR SKIP DESIRED CHANNEL

Input the channel number using the **NUMBER** keys or by pressing **CH▲▼** or **▲▼**, then press **OK** or **▷** to set to "SKIP". Repeat for each channel you want to skip. Input the channel number using the **NUMBER** keys, then press **OK** or **▷** to set to "ADD" the channel.

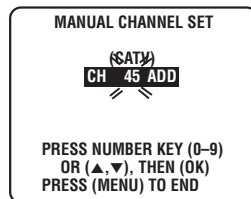

5

RETURN TO NORMAL SCREEN

Press **MENU**.

Cable Box Control

Suggested Location

Place the cable box on top of the VCR. Attach the VCR's Controller to the top of the VCR with the Controller's transmitter pointed towards the cable box's remote sensor.

ATTENTION:

The Controller can also control a DBS receiver. If both a cable box and a DBS receiver are used, position the controller so its signal reaches the remote control sensors of both the cable box and DBS receiver.

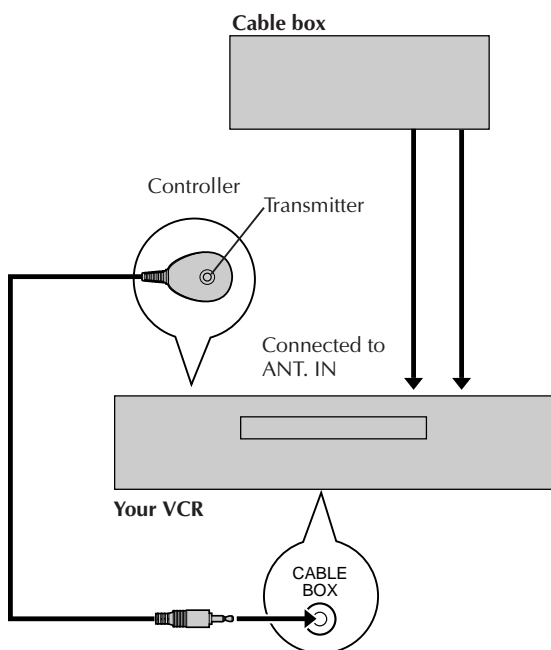
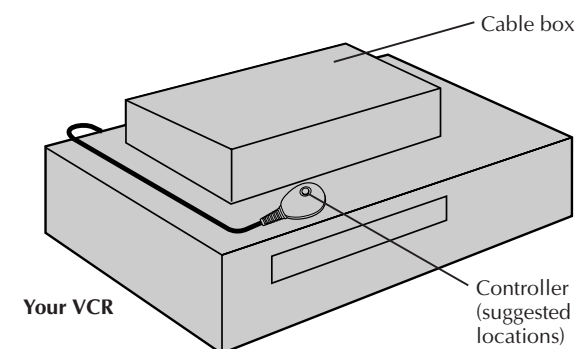

This procedure is required if you receive your TV channels through a cable box (descrambler). The Controller allows the VCR to automatically switch the cable box channel during timer-recording. The Controller is effective for recording shows that have been programmed using the VCR Plus+ system (☞ pg. 40) or Express Timer Programming (☞ pg. 44).

Situate And Connect Controller

1 SITUATE CONTROLLER

Place the Controller so that the path between its transmitter and the cable box's remote sensor is unobstructed.

2 ATTACH CONTROLLER

Fasten securely using the supplied adhesive strip.

3 CONNECT CABLE BOX TO VCR

The connection method depends on the type of cable box you have.

If your cable box has AUDIO and VIDEO OUT connectors . . .

. . . connect them to the AUDIO and VIDEO IN connectors on your VCR. Set the VCR to channel "L-1" for the rear AUDIO and VIDEO IN connectors to use the cable box.

If your cable box doesn't have AUDIO and VIDEO OUT connectors . . .

. . . connect the antenna output connector on the cable box to the ANT. IN connector on the rear of your VCR. Set the VCR tuner to the same channel as the cable box RF output (see page 16 also).

NOTE:

When connecting your cable box refer to its instruction manual.

4 CONNECT CONTROLLER TO VCR

Connect to the CABLE BOX connector on your VCR.

About Your Cable Box

This VCR has two separate methods to control your Cable Box.

- *The VCR's Wireless Remote Control Unit can control your Cable Box. This eliminates the need for a separate Cable Box Remote Control Unit.*
- *The VCR's Controller can also control your Cable Box. This allows the VCR to change your Cable Box's channel number during timer recording.*

Each method must be set up separately. To set up the VCR's Remote Control unit, refer to page 67. To set up the Controller go to page 16.

Turn on the TV and select the AV mode.

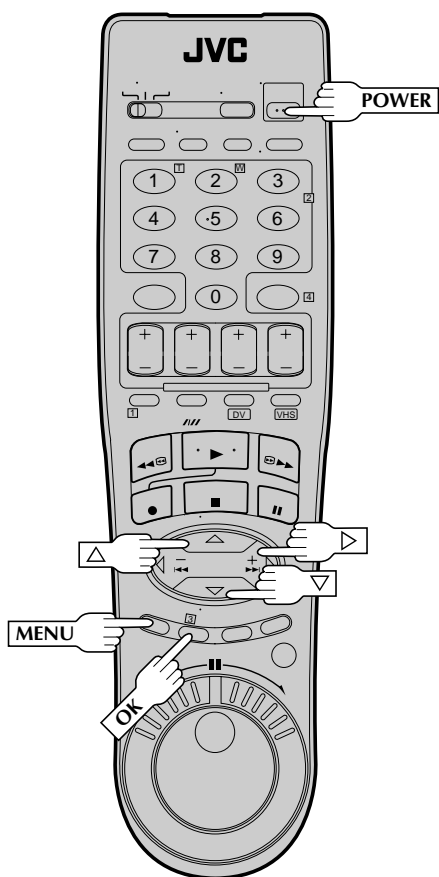
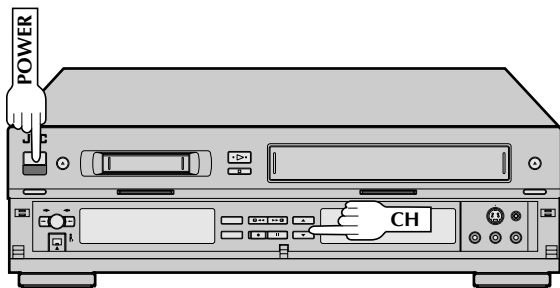

Set Cable Box Output Channel & Cable Box Brand

1 TURN ON CABLE BOX

Select a channel other than channel 9 on your cable box.

2 TURN ON THE VCR

Press **POWER**.

3 ACCESS MAIN MENU SCREEN

Press **MENU**.

4 ACCESS INITIAL SET SCREEN

Press **CH▲▼** or **▲▼** to move the highlight bar (arrow) to "INITIAL SET", then press **OK** or **▷**.

5 ACCESS CABLE BOX SET SCREEN

Press **CH▲▼** or **▲▼** to move the highlight bar (arrow) to "CABLE BOX SET", then press **OK** or **▷**.

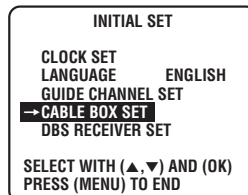

6 SELECT CABLE BOX OUTPUT CHANNEL

Your selection depends on how your cable box is connected to your VCR.

If your cable box is connected to your VCR using an RF connection . . .

. . . press **CH ▲▼** or **▲▼** until the channel number representing the cable

box's output (CH2 - CH9) appears on the screen.

If your cable box is connected to your VCR's REAR AUDIO/VIDEO IN connectors . . .

. . . press **CH ▲▼** or **▲▼** until "ON L-1 (REAR)" appears on the screen.

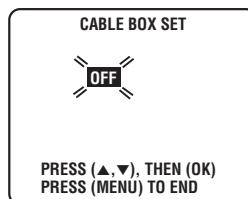

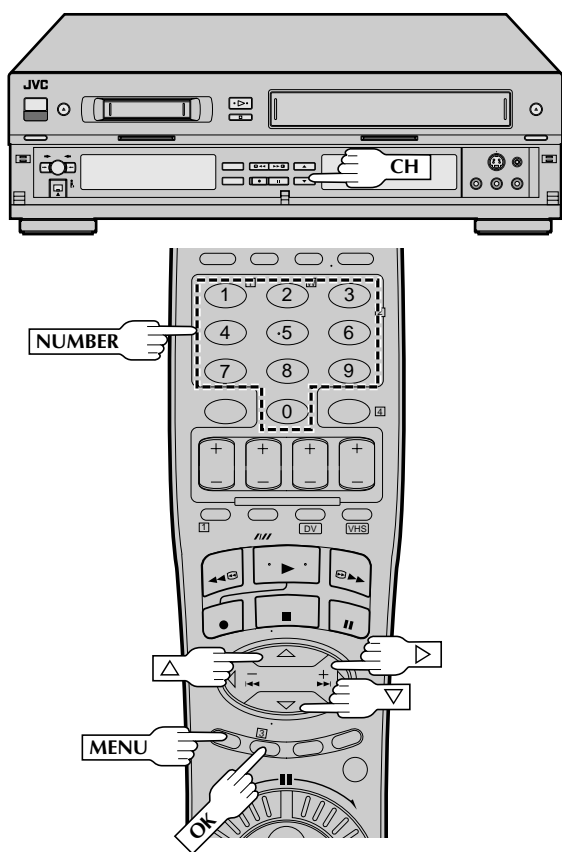

INFORMATION

When the VCR's clock has not been set (with AUTO CLOCK set to ON), if you press **OK** in step 7, "CABLE BOX USERS SET CLOCK MANUALLY" will be displayed on the screen for about 5 seconds, then the Clock Set screen will appear; perform the manual clock setting procedure on page 12. If you press **MENU** after the clock has been set, the Cable Box Brand Set screen appears.

NOTES:

- Although the supplied Controller is compatible with many different cable box brands, it is possible that it will not work with your cable box.
- If your cable box doesn't respond to any code between 1 and 25, you can't use the Controller to change cable box channels. In this case, make sure to leave the cable box turned on and tuned to the proper channel before the scheduled start of timer recording. Please contact your cable company about the possibility of exchanging your current cable box with one that is compatible with your VCR.
- The VCR can only change the cable box channel through the Controller during timer recording.
- If your cable box is one that can't be operated with a remote control (because it has no remote sensor), you can't use the Controller to change its channels. Make sure to leave the cable box turned on and tuned to the proper channel before the scheduled start of timer recording.
- If the VCR's memory backup expires because of a power failure, set the cable box output channel and brand again.
- If you are unable to set the Controller, please contact JVC toll free at 1-800-252-5722.

ACCESS CABLE BOX BRAND SET SCREEN

Press **OK**.

ENTER CABLE BOX BRAND

Press the appropriate **NUMBER** keys to enter the Cable Box Code from the CABLE BOX BRAND LIST shown below, then press **OK**.

CABLE BOX BRAND SET



**PRESS NUMBER KEY (0-9)
THEN (OK) TO TEST
PRESS (MENU) TO END**

- If the cable box's channel changes to 9, setting is complete. Press **OK** and "CABLE BOX CONTROL IS ON" appears on the screen for about 5 seconds, then it returns to the normal screen.
- If the cable box's channel does not change to 9, press **CH ▲▼** or **Δ∇** to move the highlight bar (arrow) to "NO", then press **OK**. By entering another code, repeat step 8 until the cable box's channel changes to 9.
- If the channel does not change after going through all the code numbers listed for your model of cable box, then try all the other numbers between 1 and 25.

CABLE BOX BRAND LIST

BRAND	CODE
ARCHER	1, 5, 17
CABLETENNA	1, 17
CABLEVIEW	15, 16, 17, 21, 25
CITIZEN	15, 16, 17, 21, 25
CURTIS	2, 8
DIAMOND	1, 17
EASTERN	19
GC BRAND	15, 16, 17, 21, 25
GEMINI	15
GENERAL INSTRUMENTS	1, 4, 6, 11, 12, 15
HAMLIN	10, 18, 19, 23
JASCO	15
JERROLD	1, 4, 6, 11, 12, 15
NOVAVISION	2, 8
OAK	7, 20
PANASONIC	13, 14
PULSER	15, 16, 17, 21, 25
RCA	13, 14
REGAL	10, 18, 19, 23
REGENCY	19
REMBRANDT	1, 16, 17
SAMSUNG	5, 16, 24
SCIENTIFIC ATLANTA	2, 8
SIGMA	7, 20
SL MARX	5, 16, 17, 24, 25
SPRUCER	13, 14
STARGATE	5, 15, 16, 17, 21, 24, 25
TELEVIEW	5, 16, 24
TOCOM	1, 4, 16
UNIKA	1, 17
UNIVERSAL	16, 17, 25
VIDEOWAY	3, 9, 22
ZENITH	3, 9, 22

DBS Receiver Control

Suggested Location

Place the DBS (Direct Broadcast Satellite) receiver on top of the VCR. Attach the VCR's Controller to the top of the VCR with the Controller's transmitter pointed towards the DBS receiver's remote sensor.

ATTENTION:

The Controller can also control a cable box. If both a DBS receiver and a cable box are used, position the controller so its signal reaches the remote control sensors of both the DBS receiver and cable box.

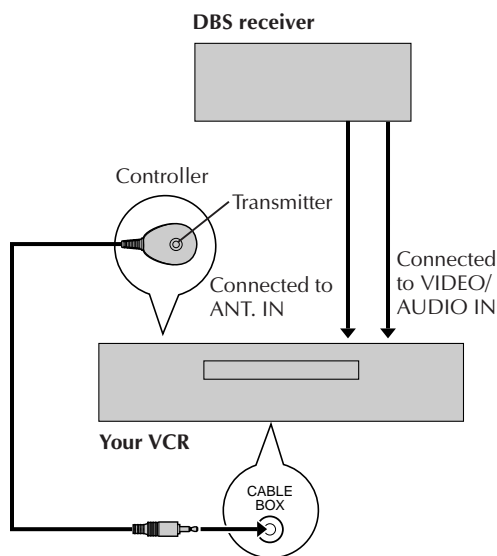
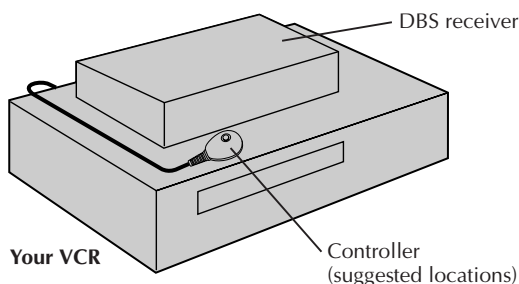

About Your DBS Receiver

This VCR has two separate methods to control your DBS Receiver.

- The VCR's Wireless Remote Control Unit can control the power and channel functions of your DBS Receiver. For these functions, the need for a separate DBS Receiver Control Unit is eliminated.
- The VCR's Controller can also control your DBS Receiver. This allows the VCR to change your DBS receiver's channel number during timer recording.

Each method must be set up separately. To set up the VCR's Remote Control unit, refer to page 68. To set up the Controller go to page 19.

The following procedure is required if you receive satellite channels through a DBS (Direct Broadcast Satellite) Receiver. The Controller allows the VCR to automatically switch the DBS Receiver's channels during timer recording.

NOTES:

- The VCR can automatically change the DBS Receiver channels using the controller when the VCR has been programmed using Express Timer Programming (☞ pg. 44). Because satellite programming does not use PlusCode; the Controller cannot change the DBS Receiver channels during the VCR Plus+ Timer Recording.
- If a cable box is also used it is recommended that you connect the DBS receiver to your VCR's A/V inputs and the cable box to your VCR's antenna input.

Situate And Connect Controller

1 SITUATE CONTROLLER

Place the Controller so that the path between its transmitter and the DBS receiver's remote sensor is unobstructed.

2 ATTACH CONTROLLER

Fasten securely using the supplied adhesive strips.

3 CONNECT DBS RECEIVER TO VCR

The connection method depends on the type of DBS receiver you have.

If your DBS receiver has AUDIO and VIDEO OUT connectors . . .

. . . connect them to the AUDIO and VIDEO IN connectors on your VCR. Set the VCR to channel "L-1" for the rear AUDIO and VIDEO IN connectors to use the DBS receiver.

If your DBS receiver doesn't have AUDIO and VIDEO OUT connectors . . .

. . . connect the antenna output connector on the DBS receiver to the ANT. IN connector on the rear of your VCR.

Set the VCR's tuner to the same channel as the DBS receiver's RF output. (See page 19 also.)

NOTE:

When connecting your DBS receiver refer to its instruction manual.

4 CONNECT CONTROLLER TO VCR

Connect to the CABLE BOX connector on your VCR.

Turn on the TV and select the AV mode.

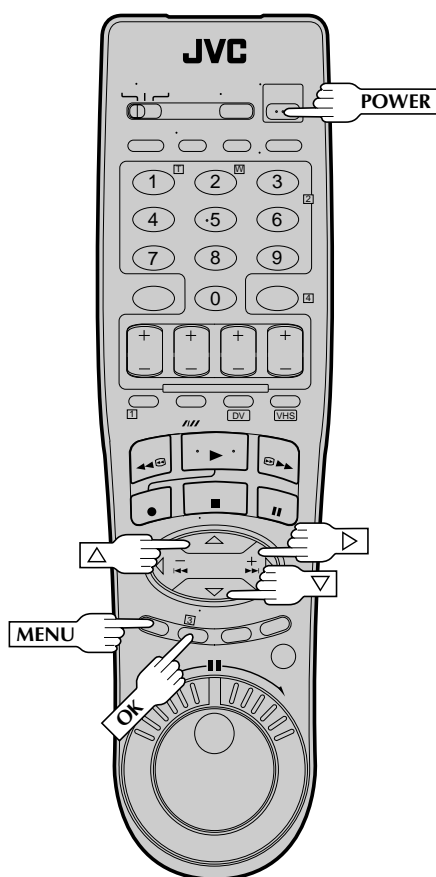
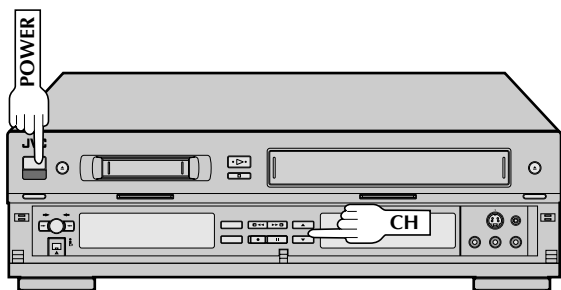

Set DBS Receiver Output Channel & DBS Receiver Brand

1 TURN ON DBS RECEIVER

Select a channel other than channel 55, 100 or 205 on your DBS receiver.

2 TURN ON THE VCR

Press **POWER**.

- Set the VCR to the channel (3 or 4 or L-2 or L-1) on which the signals from the DBS receiver are received.

3 ACCESS MAIN MENU SCREEN

Press **MENU**.

4 ACCESS INITIAL SET SCREEN

Press **CH▲▼** or **▲▼** to move the highlight bar (arrow) to "INITIAL SET", then press **OK** or **▷**.

5 ACCESS DBS RECEIVER SET SCREEN

Press **CH▲▼** or **▲▼** to move the highlight bar (arrow) to "DBS RECEIVER SET", then press **OK** or **▷**.

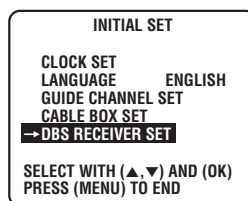

6 SELECT DBS RECEIVER OUTPUT CHANNEL

Your selection depends on how your DBS receiver is connected to your VCR.

If your DBS receiver is connected to your VCR using an RF connection . . .

. . . press **CH ▲▼** or **▲▼** until the channel number representing the DBS receiver's output (CH3 – CH4) appears on the screen.

If your DBS receiver is connected to your VCR's REAR AUDIO/VIDEO IN connectors . . .

. . . press **CH ▲▼** or **▲▼** until "ON L-1 (REAR)" appears on the screen.

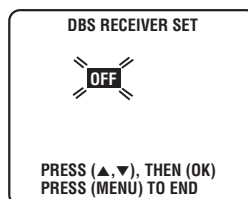

CONTINUED ON NEXT PAGE

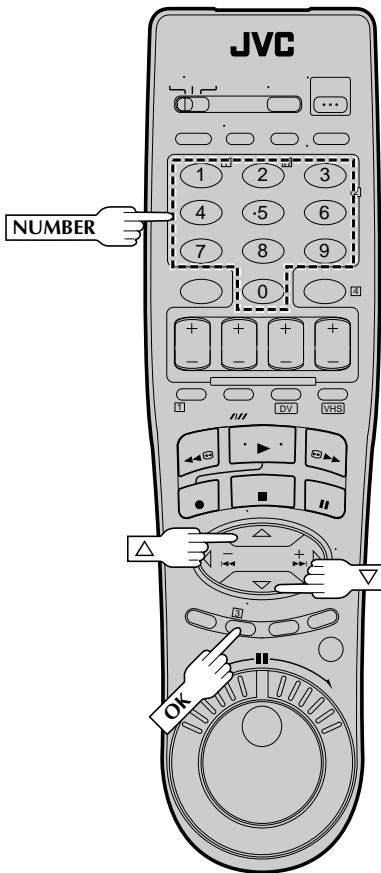
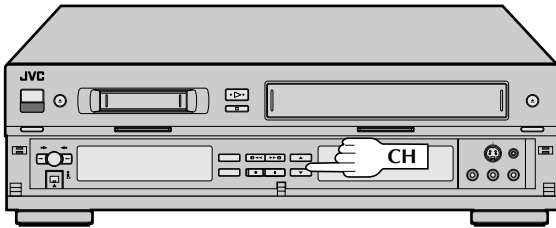

7

ACCESS DBS RECEIVER BRAND SET SCREEN

Press **OK**.

8

SET DBS RECEIVER BRAND

Press the appropriate **NUMBER** keys to enter the DBS Receiver Code from the following list, then press **OK**.



BRAND	CODE
JVC (DISH Network)	51
ECHOSTAR (DISH Network)	51
PRIMESTAR	50
SONY (DSS)	41
RCA (DSS)	40

- After **OK** is pressed, the program currently received through the DBS receiver will appear for about 10 seconds.
- If the DBS receiver's channel changes to the channel listed below for your brand of DBS receiver, setting is complete. Press **OK** and "DBS RECEIVER CONTROL IS ON" appears on the screen for about 5 seconds, then it returns to the normal screen.

JVC → 100
 ECHOSTAR → 100
 PRIMESTAR → 55
 SONY → 205
 RCA → 205

- If the DBS receiver's channel does not change as shown above, press **CH ▲▼** or **▲▼** to move the highlight bar (arrow) to "NO", then press **OK**. Re-enter the correct code.

NOTES:

- It is possible that the Controller will not work with all types of DBS receiver.
- If your DBS receiver doesn't respond to the code, you can't use the Controller to change satellite channels. In this case, make sure to leave the DBS receiver turned on and tuned to the proper channel before the scheduled start of timer recording.
- The VCR can only change the satellite channel through the Controller during timer recording.
- If your DBS receiver is one that can't be operated with a remote control (because it has no remote sensor), you can't use the Controller to change its channels. Make sure to leave the DBS receiver turned on and tuned to the proper channel before the scheduled start of timer recording.
- If you are unable to set the Controller, please contact JVC toll free at 1-800-252-5722.

Simple Playback

Turn on the TV and select the AV mode.

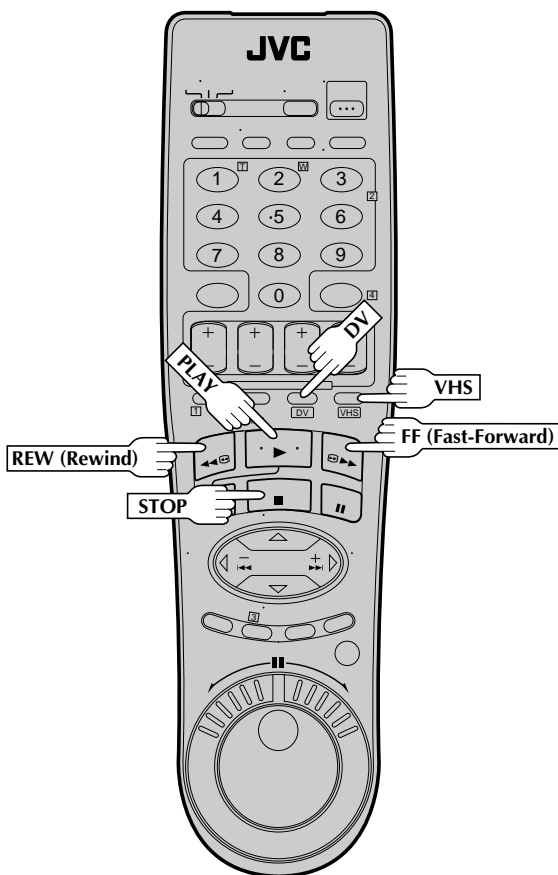
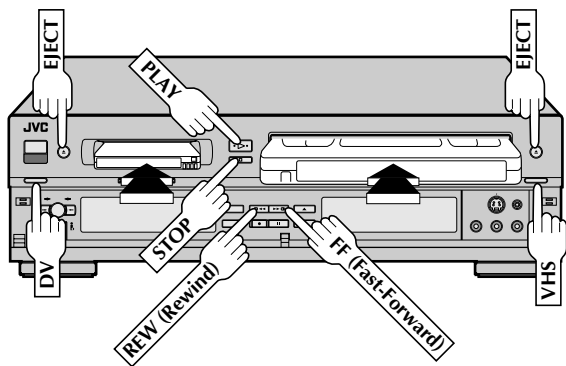

1 LOAD A CASSETTE

Make sure the window side is up, the rear label side is facing you and the arrow on the front of the cassette is pointing towards the VCR. Don't apply too much pressure when inserting.

- The VCR's power comes on automatically.
- The counter is automatically reset to "0:00:00" (VHS deck only).
- **VHS deck**
If the cassette's record safety tab has been removed, playback begins automatically.
- **DV deck**
If the cassette's erase protection switch is set to "SAVE", playback begins automatically.

2 SELECT DECK

Press **VHS** or **DV**. The VHS or DV indicator lights.

3 FIND PROGRAM START POINT

If the tape is advanced past the start point, press **REW**. To go forward, press **FF**.

4 START PLAYBACK

Press **PLAY**. "VIDEO CALIBRATION" appears on the screen (when VIDEO CALIBRATION is set to "ON" (VHS deck only) [see pg. 34](#)).

5 STOP PLAYBACK

Press **STOP**. Then press **EJECT** on the VHS deck or DV deck to remove the cassette.

Usable cassettes

VHS deck

Full-Size VHS
T-30 (ST-30**)
T-60 (ST-60**)
T-90
T-120 (ST-120**)
T-160 (ST-160**)
ST-210**

Compact VHS*
TC-20 (ST-C20**)
TC-30 (ST-C30**)
TC-40 (ST-C40**)

* Compact VHS camcorder recordings can be played on this video recorder. Simply place the recorded cassette into a VHS Cassette Adapter and it can be used just like any full-sized VHS cassette.

** This VCR can record on regular VHS and Super VHS cassettes. While only VHS signals can be recorded on regular VHS cassettes*, both VHS and Super VHS signals can be recorded and played back using Super VHS cassettes.

* By using S-VHS ET it is possible to record and play back with S-VHS picture quality on VHS cassettes with this VCR.

DV deck

Only cassettes marked **Mini DV** can be used with the DV deck.

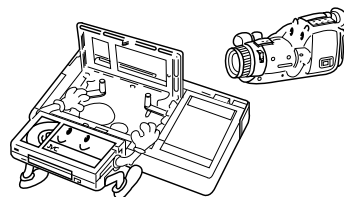

Simple Recording

Turn on the TV and select the AV mode.

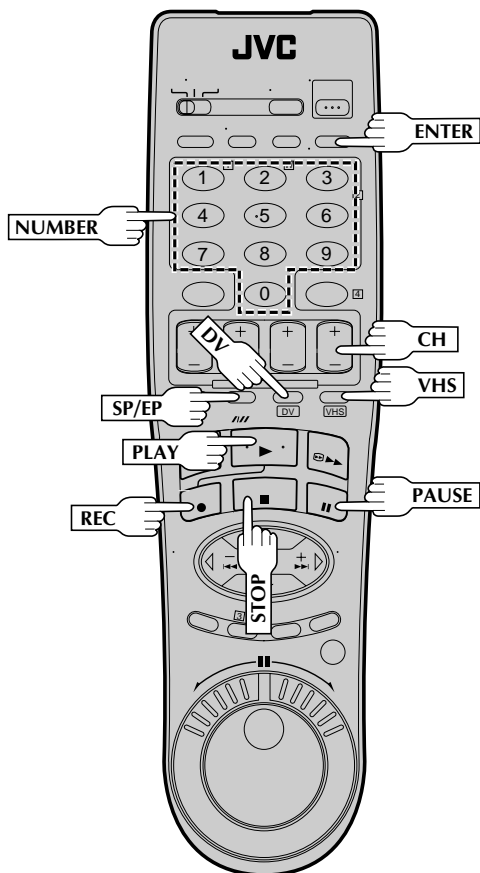
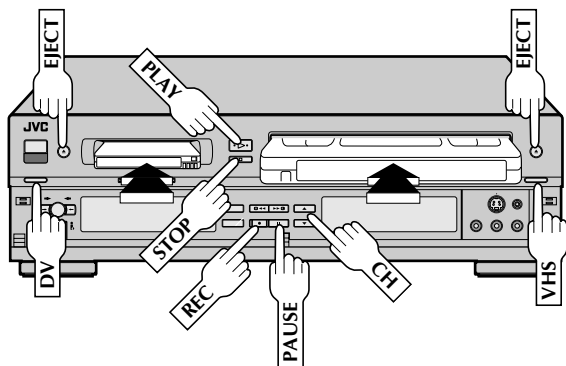

1 LOAD A CASSETTE

Insert a VHS (or S-VHS) cassette with the record safety tab intact, or a Mini DV cassette with the erase protection switch set to "REC".

2 SELECT DECK

Press **VHS** or **DV**. The VHS or DV indicator lights.

3 SELECT RECORDING CHANNEL

Press **CH▲▼** (+/-). Or press the appropriate **NUMBER** keys, then press **ENTER**. (The channel changes after a few seconds whether you press **ENTER** or not.)

4 SET TAPE SPEED

Press **SP/EP** (**SP/LP** for the DV deck) to set the recording speed.

5 START RECORDING

Press and hold **REC** and press **PLAY** on the remote control, or press **REC** on the VCR's front panel.

Video Calibration takes place at the beginning of both the first SP and the first EP recording after inserting the cassette (when Video Calibration is set to "ON" (VHS deck only) [pg. 34](#)).

6 PAUSE/RESUME RECORDING

Press **PAUSE**. Press **PLAY** to resume recording.

- During record pause, you can change the recording channel by using the **CH▲▼** (+/-) buttons or **NUMBER** keys.

Video Calibration will not take place if the tape speed is changed while in record pause mode.

7 STOP RECORDING

Press **STOP**. Then press **EJECT** on the VHS or DV deck to remove the cassette.

NOTES:

- It is not possible to record a TV program on both the VHS deck and the DV deck simultaneously. In addition, it is not possible to record simultaneously from the same external input.
- When you record a tape on the DV deck with the recording speed set to "LP", we recommend that you play that tape back on this deck. Digital video recorder from other manufacturers may not be able to play the tape properly.

Playback Features

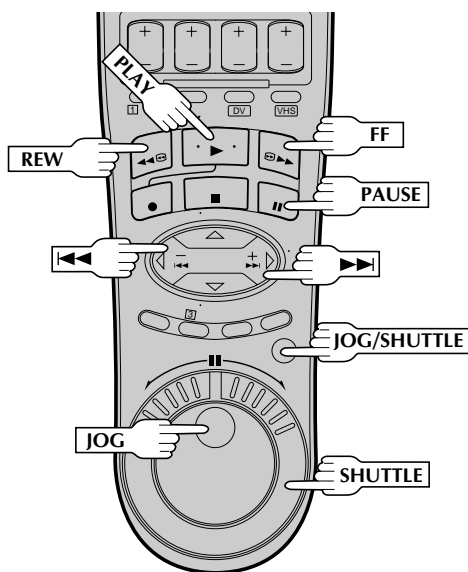
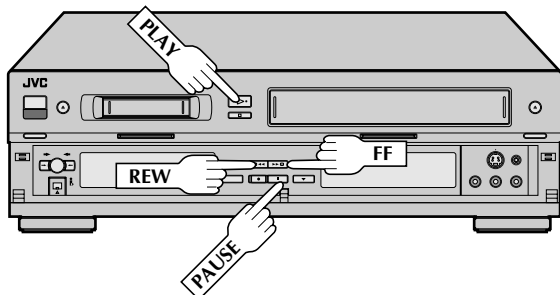

High-Speed Search

1

ACTIVATE HIGH-SPEED SEARCH

During playback or still, turn the **SHUTTLE** ring to the right for forward high-speed search, or to the left for reverse high-speed search.

OR

During playback or still, press **FF** for forward high-speed search, or **REW** for reverse high-speed search.

- The search speed is 7 times normal playback speed with SP recordings, and 21 times normal with EP recordings.

To resume normal playback, press **PLAY**.

NOTES:

- For short searches, during playback or still, press and hold **FF** or **REW**. When released, normal playback resumes.
- To use the **JOG** dial/**SHUTTLE** ring, first press the **JOG/SHUTTLE** button on the remote control so that the button lights up.

Still Picture/Frame-By-Frame Playback

1

PAUSE DURING PLAYBACK

Press **PAUSE**.

2

ACTIVATE FRAME-BY-FRAME PLAYBACK

Turn the **JOG** dial to the right for forward frame-by-frame playback, or to the left for reverse frame-by-frame playback.

OR

Press **PAUSE** repeatedly to advance one frame at a time.

OR

Press **▶▶** repeatedly for forward frame-by-frame playback or **◀◀** repeatedly for reverse frame-by-frame playback. (VHS deck only)

To resume normal playback, press **PLAY**.

Slow Motion/Reverse Slow Motion/Reverse Motion Playback

1

ACTIVATE SLOW-MOTION PLAYBACK

For hands-free slow-motion, press **◀◀** during playback to decrease speed in the forward direction. Continue to press **◀◀** to select the reverse slow motion, reverse play and reverse search modes.

OR

During playback or still picture, turn the **SHUTTLE** ring to the right for forward slow motion, or to the left for reverse slow motion.

OR

During still picture, press and hold **▶▶** for forward slow motion, or press and hold **◀◀** for reverse slow motion. Release to return to still picture. (VHS deck only)

To resume normal playback, press **PLAY**.

ATTENTION (VHS Deck Only)

- Picture may not appear during high-speed search with an EP-recorded tape.
- In the high-speed search, still, slow motion or frame by frame playback mode, the picture will be distorted, and there will be a loss of colour.
- When normal playback resumes from search, still, slow motion or frame-by-frame playback, the picture may jitter vertically momentarily depending on the type of TV being used.

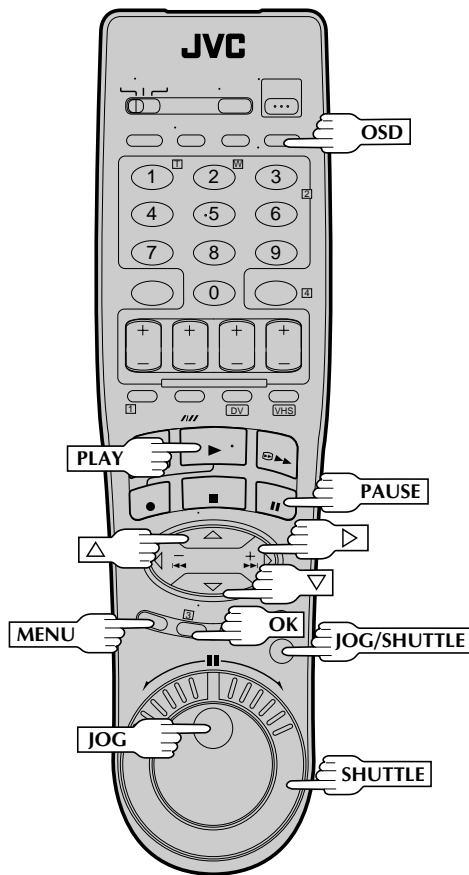

You can also use the remote control's **JOG dial/SHUTTLE ring** for the operations described on this page. First press the **JOG/SHUTTLE** button on the remote control so that the button lights up before use. Refer to the **SHUTTLE ring** illustration below as you read the procedures.

NOTE: When using the **JOG dial** during playback on the DV deck, turn the **JOG dial** slowly.

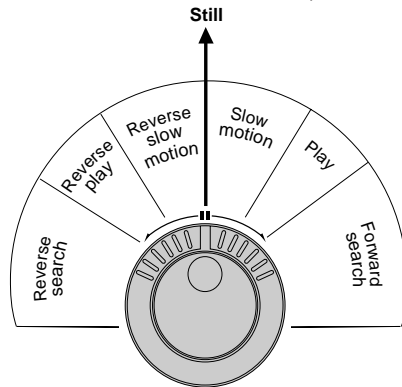

Shuttle Ring Modes

Forward search	: 3 steps
Normal playback	
Slow motion	: 2 steps
Reverse slow motion	: 2 steps
Reverse playback	
Reverse search	: 3 steps

High-Speed Search (On the Remote Control)

1 ACTIVATE HIGH-SPEED SEARCH

1 During playback or still, turn the **SHUTTLE** ring all the way to the right for forward high-speed search, or to the left for reverse high-speed search. By releasing **SHUTTLE** still picture playback is selected.

To resume normal playback, press **PLAY**.

Variable-Speed Search/ Reverse Motion Playback (VHS deck only, On the Remote Control)

1 ACTIVATE VARIABLE-SPEED SEARCH

1 During playback or still, turn the **SHUTTLE** ring to the right for forward variable-speed search, or to the left for reverse variable-speed search.

To resume normal playback, press **PLAY**.

Still Picture/Frame-By-Frame Playback (On the Remote Control)

1 PAUSE DURING PLAYBACK

Press **PAUSE**.

2 ACTIVATE FRAME-BY-FRAME PLAYBACK

2 Turn the **JOG dial** to the right for forward frame-by-frame playback, or to the left for reverse frame-by-frame playback.

To resume normal playback, press **PLAY**.

Slow Motion/Reverse Slow Motion (On the Remote Control)

1 ACTIVATE SLOW-MOTION PLAYBACK

1 During playback or still picture, turn the **SHUTTLE** ring to the right for forward slow motion, or to the left for reverse slow motion.

To resume normal playback, press **PLAY**.

Superimpose

This function, switchable between ON and OFF, determines whether or not operational indicators will appear on screen.

- 1** **ACCESS MAIN MENU SCREEN**
Press **MENU**.
- 2** **ACCESS MODE SET SCREEN**
Move the highlight bar (arrow) to "MODE SET" by pressing **CH▲▼** or **△▽**, then press **OK** or **▷**.
- 3** **SELECT SUPERIMPOSE SET MODE**
Move the highlight bar (arrow) to "SUPERIMPOSE" by pressing **CH▲▼** or **△▽**, then press **OK** or **▷** to select the desired mode:
 - a- Select "ON" if you want the superimposed operational indications on the TV screen.
 - b- Select "OFF" if you do not want the superimposed operational indications on the screen.
- 4** **RETURN TO NORMAL SCREEN**
Press **MENU**.

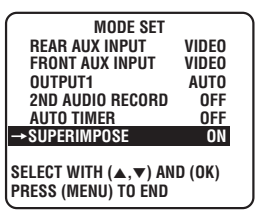

To recall an indication

- 1 Press **OSD**.
 - All indications corresponding to the current status are displayed for 5 seconds. After that, the counter information and RECORD/PAUSE if in the Record Pause mode, are left displayed on the screen.
- 2 Press **OSD** again to clear the display.
 - The RECORD/PAUSE indication is left displayed on the screen.

NOTES:

- If you engage the Record Pause mode, RECORD/PAUSE is displayed regardless of the Superimpose mode setting.
- If you select a channel on which no signal is received, the channel number is displayed regardless of the Superimpose mode setting.

The superimposed indication on the TV screen tells you what the VCR is doing.

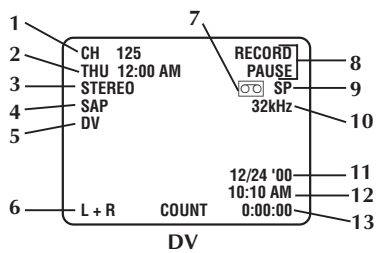
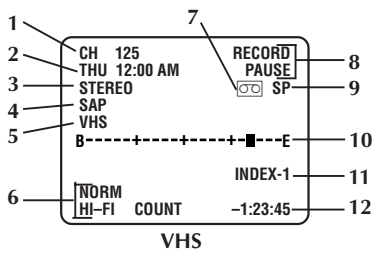

- 1- Tuned-in channel or AUX(iliary) mode
When the channel is changed, the new channel is displayed on the screen for 5 seconds.
- 2- Clock time
- 3- Stereo program indication
- 4- Second Audio Program indication
- 5- VHS/DV indicator
- 6- Audio mode indications
- 7- "Cassette Loaded" mark
When a cassette is loaded, the mark is displayed for 5 seconds. It blinks when the VCR's EJECT button is pushed.
- 8- Operation mode
When the operation mode is changed, the new mode is displayed — RECORD (5 sec.), PLAY (5 sec.), FF/REW (5 sec. when engaged from Stop mode), RECORD PAUSE (for as long as Pause is engaged), and ITR **:*(5 sec.).

- 9- Tape speed indication
- 10- Tape position indicator (VHS)
Sound Mode indicator (DV)
- 11- INDEX indication (VHS)
"STILL" and "SLOW 1/6" are displayed during still picture and slow motion respectively.
Month/Day/Year at recording (DV)
- 12- Counter reading (VHS)
Switchable to the tape remaining time display
Time at recording (DV)
- 13- Time Code (DV)

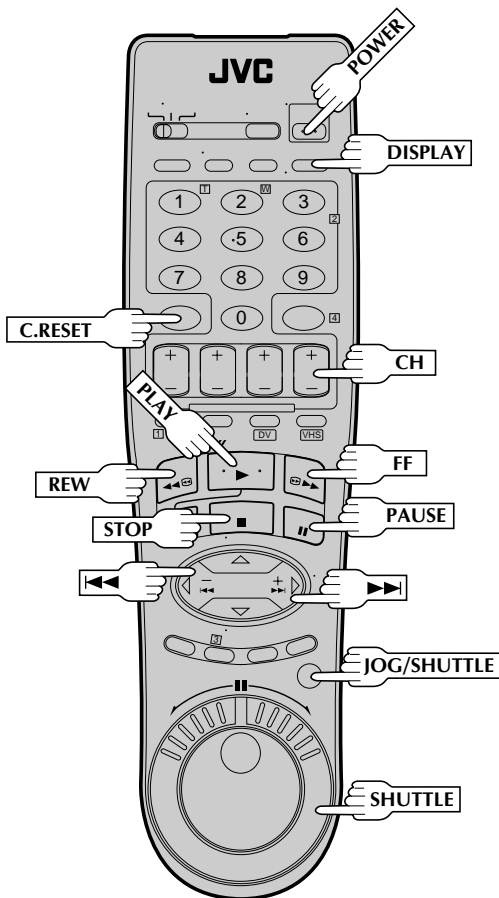
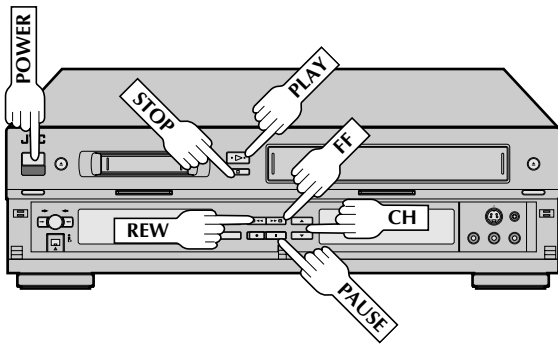

Manual Tracking (VHS deck only)

Once playback begins, the VCR's automatic tracking function is engaged. If tracking noise appears in the picture, you can override this and make the adjustment manually.

1 ENGAGE MANUAL TRACKING MODE

During playback, press the **CH**▲ and ▼ buttons on the VCR's front panel simultaneously to cancel the automatic tracking mode and enable manual tracking adjust.

2 ADJUST MANUAL TRACKING

Press **CH**▲ (+) or ▼ (-) on the VCR's front panel or remote. Press briefly for fine adjust, or press and hold for coarse adjust. Watch the screen and continue adjusting until optimum picture and sound quality are achieved.

3 RE-ENGAGE AUTOMATIC TRACKING

Press the **CH**▲ and ▼ buttons on the VCR's front panel simultaneously.

- When automatic tracking is re-engaged, Video Calibration is automatically activated.

NOTES:

- To obtain a noiseless still picture it may be necessary to adjust tracking in slow playback and then engage Pause.
- Manual tracking is possible during hands-free slow-motion. During hands-free slow-motion playback, simply press **CH**▲ (+) or ▼ (-) on the VCR's front panel or remote to adjust tracking.

Index Search (VHS deck only)

Index codes are placed on the tape at the start of each recording. You can find and automatically play back from the start of any recording using the Index Search function.

1 START SEARCH

While the tape is stopped, press **◀◀** or **▶▶**.

2 ACCESS DISTANT CODE

To access a recording 2–9 index codes away, press **◀◀** or **▶▶** repeatedly until the correct number is displayed on screen (only if "SUPERIMPOSE" is set to "ON" (pg. 25)). Playback begins automatically when the desired recording is located.

- If necessary press **REW** or **FF** when play starts to search visually to find the very beginning of the desired program.

NOTE:

An index code is not placed on the tape when recording is paused and then resumed.

Repeat Playback (VHS deck only)

1

START REPEAT

Press and hold **PLAY** (until "▶" blinks on the front display panel) during playback, then release.



- The entire tape is played back 50 times.

2

STOP REPEAT

To stop, press **STOP** at any time.

NOTE:

Pressing **PLAY**, **REW**, **FF**, **PAUSE** or **◀◀ ▶▶** also stops Repeat Playback.

Counter Reset (VHS deck only)

1

RESET COUNTER TO ZERO

Press **C.RESET**.

NOTE:

By pressing the **DISPLAY** button, you can change the display to show the counter reading, channel number, clock time or tape remaining time. (Channel number is not displayed during playback.)

Next-Function Memory

The Next Function Memory "tells" the VCR what to do after rewinding. Before continuing, ensure that the VCR is in stop mode.

- a- For Automatic Start Of Playback After Tape Rewind . . .
... press **REW**, then press **PLAY** within 2 seconds.
- b- For Automatic Power Off After Tape Rewind . . .
... press **REW**, then press **POWER** within 2 seconds.

Display Mode Setting (DV Deck)

Set "DISPLAY" to "ON" to display the date and time at the original recording.

- 1 Press **MENU** to access the Main Menu screen.
- 2 Move the highlight bar (arrow) to "DV MODE SET" by pressing **CH▲▼** or **▲▼**, then press **OK** or **▷**.
- 3 Move the highlight bar (arrow) to "DISPLAY" by pressing **CH▲▼** or **▲▼**, then press **OK** or **▷** to select "ON" or "OFF".
- 4 Press **MENU** to return to the normal screen.

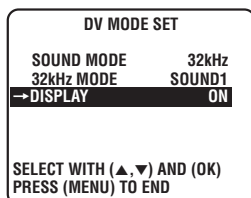

Tape Position Indicator (VHS deck only)

The Tape position indicator appears on screen when, from the stop mode, you press **FF**, **REW**, or use the **SHUTTLE** ring, or perform an Index Search. The position of "■" in relation to "B" (Beginning) or "E" (End) shows you where you are on the tape.

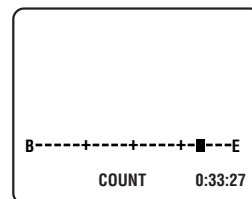

NOTES:

- "SUPERIMPOSE" must be set to "ON", or the indicator will not appear (pg. 25).
- It may take a few seconds for the Tape Position Indicator to be displayed.

Time Code (DV Deck)

During recording, a time code is recorded on the tape. This time code is used to confirm the position on the tape when playing or editing a tape. To perform Random Assemble Editing (pg. 52), time code is necessary.

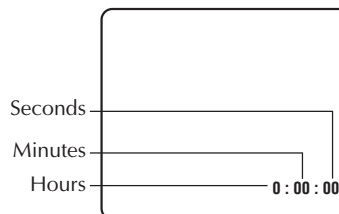

NOTES:

The presence of a blank (unrecorded) portion in the middle of a tape can result in misoperation.

A "blank portion" of a tape is a section where nothing is recorded on the tape. If you start making a recording in a blank portion of a tape, the time codes will start from "0:00:00" again. If identical time codes are recorded in two different places on a tape, Random Assemble Editing and other similar functions might not operate properly.

In the following circumstances, you should play the tape and confirm where a scene ends, and then begin recording from there:

- When starting to record in the middle of a tape on which a recording has already been made.
- When you have made a recording on a tape, then played that recording back in order to check it, and now wish to continue recording.
- When you lost power or the batteries died while you were recording with a camcorder.

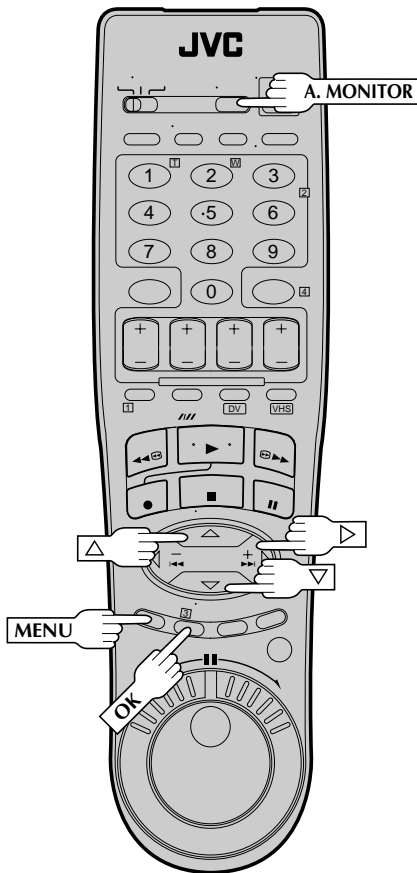
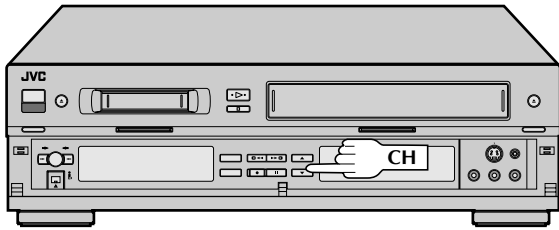

Picture Control (VHS deck only)

This feature helps you to adjust the playback picture quality according to your preference. *The default setting is "AUTO."

1 ACCESS MAIN MENU SCREEN

Press MENU.

2 ACCESS VHS MODE SET SCREEN

Move the highlight bar (arrow) to "VHS MODE SET" by pressing CH▲▼ or Δ▽, then press OK or ▷.

3 SELECT PICTURE CONTROL SET MODE

Move the highlight bar (arrow) to "PICTURE CONTROL" by pressing CH▲▼ or Δ▽, then press OK or ▷ to select the desired mode.

VHS MODE SET	
S-VHS ET	OFF
S-VHS MODE	ON
VIDEO CALIBRATION	ON
→ PICTURE CONTROL	AUTO
DIGITAL TBC/NR	ON
VIDEO STABILIZER	OFF
NEXT PAGE	
SELECT WITH (▲, ▼) AND (OK)	
PRESS (MENU) TO END	

AUTO*: Normally select "AUTO".

It automatically adjusts the picture quality.

* When "VIDEO CALIBRATION" is set to "OFF" (pg. 34), you can only select NORM instead of AUTO.

EDIT: Select when you dub tapes.

SOFT: Select when you want to soften the picture.

SHARP: Select when you want to sharpen the picture.

NOTE:

- When you select "EDIT", "SHARP" or "SOFT", the selected mode will not change until you select again.
- When you select "EDIT" to dub tapes, be sure to select "AUTO" (or "NORM" when "VIDEO CALIBRATION" is set to "OFF") after you finish dubbing the tapes.

4 RETURN TO NORMAL SCREEN

Press MENU.

NOTE:

Select "EDIT" when you are dubbing tapes. Refer to page 58.

Video Stabilizer (VHS deck only)

By activating the Video Stabilizer you can correct vertical vibrations in the picture when playing back unstable EP recordings that were made on another VCR. When this function is set to "ON", vertical vibration will be automatically corrected.

*The default setting is "OFF".

1 ACCESS MAIN MENU SCREEN

Press **MENU**.

2 ACCESS VHS MODE SET SCREEN

Move the highlight bar (arrow) to "VHS MODE SET" by pressing **CH▲▼** or **▲▼**, then press **OK** or **▷**.

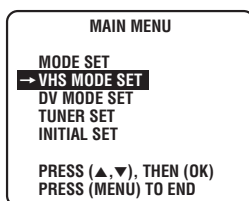

3 ACTIVATE VIDEO STABILIZER

Move the highlight bar (arrow) to "VIDEO STABILIZER" by pressing **CH ▲▼** or **▲▼**, then press **OK** or **▷** to set to "ON".

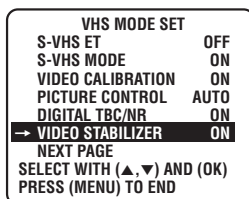

4 RETURN TO NORMAL SCREEN

Press **MENU**.

Select The Soundtrack (VHS deck)

The VHS deck can record two soundtracks simultaneously (Normal and Hi-Fi) and play back the selected one, or both together. Or, when viewing a pre-recorded tape that contains two separate Hi-Fi audio programs, you can choose to listen to either one by selecting either "Hi-Fi L" or "Hi-Fi R".

You can select the soundtrack by simply pressing the remote control's **A. MONITOR** button as follows:

Hi-Fi → Hi-Fi L → Hi-Fi R → Normal → Mix → Hi-Fi

NOTE:

If the tape being played back has no Hi-Fi soundtrack, the Normal soundtrack will be heard no matter what choice you make.

NOTES:

- When you finish viewing the tape, be sure to set it back to "OFF".
- Regardless of the setting, this function has no effect during recording and during special-effects playback.
- The Superimpose mode indications may jitter vertically when "VIDEO STABILIZER" is set to "ON".
- To watch recordings with close-caption, it is necessary to set the Video Stabilizer function to "OFF".

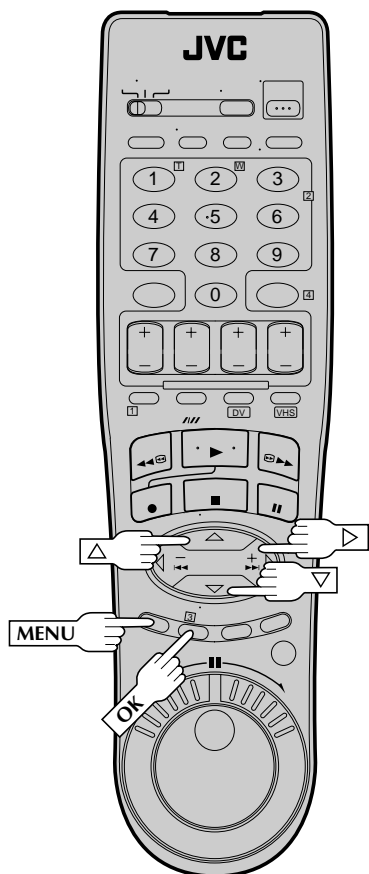
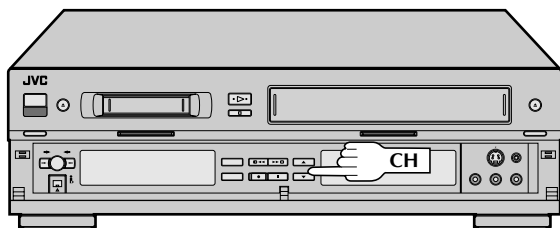

Digital TBC/NR (VHS deck only)

Your VCR is equipped with the Digital TBC (Time Base Corrector) that removes jitter from fluctuating video signals to deliver a stable picture even with old tapes and rental cassettes. The on/off of Digital 3-DNR (Noise Reduction) which cuts noise and enables clear picture reproduction is also linked to this function.

* The default setting is "ON".

We recommend that you use the Digital TBC feature when...

- ... playing back a tape recorded on a camcorder.
- ... playing back a tape repeatedly used.
- ... using this VCR as the player for editing.

1 ACCESS MAIN MENU SCREEN

Press **MENU**.

2 ACCESS VHS MODE SET SCREEN

Move the highlight bar (arrow) to "VHS MODE SET" by pressing **CH** ▲▼ or ▲▽, then press **OK** or ▷.

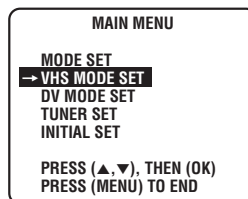

3 SELECT DIGITAL TBC/NR SET MODE

Move the highlight bar (arrow) to "DIGITAL TBC/NR" by pressing **CH** ▲▼ or ▲▽, then press **OK** or ▷ to set to "ON".

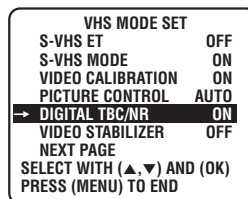

4 RETURN TO NORMAL SCREEN

Press **MENU**.

NOTES:

- If you play back a tape recorded under poor TV reception condition, there may be cases where the picture becomes more stable with Digital TBC/NR set to off.
- When Digital TBC/NR is set to on, if you play back a tape where certain types of signals are recorded (using a PC or some character generators), the playback picture may be distorted. If this is the case, turn off Digital TBC/NR.
- Digital TBC/NR and Video Stabilizer (pg. 29) cannot be used at the same time; if you turn on Digital TBC/NR when "VIDEO STABILIZER" is set to "ON", Video Stabilizer will be automatically turned "OFF". Make sure Digital TBC/NR is off when you want to use Video Stabilizer.

Digital R³ (VHS deck only)

Digital R³ picture system applies edge correction to the luminance signal to enhance detail.

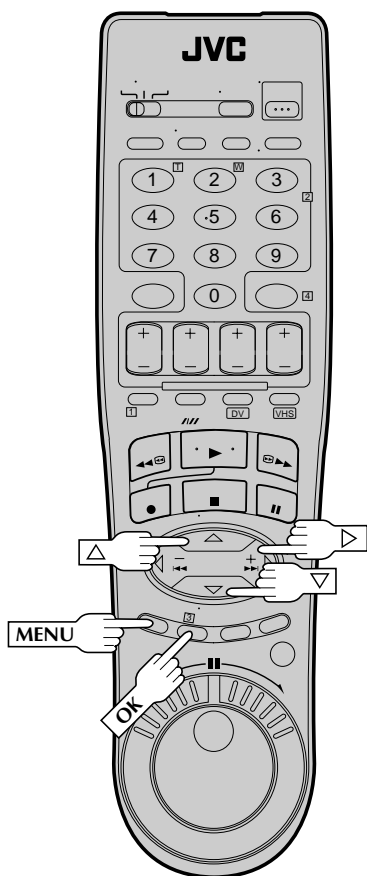
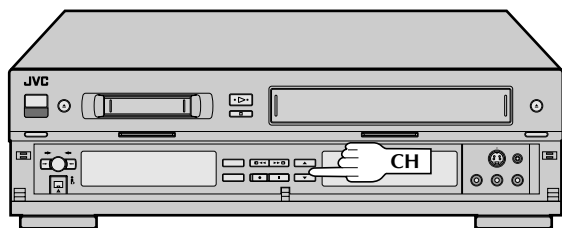

1 ACCESS MAIN MENU SCREEN

Press MENU.

2 ACCESS VHS MODE SET SCREEN

Move the highlight bar (arrow) to "VHS MODE SET" by pressing CH▲▼ or ▲▼, then press OK or ▷.

MAIN MENU	
MODE SET	
→ VHS MODE SET	
DV MODE SET	
TUNER SET	
INITIAL SET	
PRESS (▲, ▼), THEN (OK)	
PRESS (MENU) TO END	

3 SELECT DIGITAL R3 SET MODE

Move the highlight bar (arrow) to "DIGITAL R3" by pressing CH▲▼ or ▲▼, then press OK or ▷ to set to "ON".

VHS MODE SET	
→ S-VHS ET	OFF
S-VHS MODE	ON
VIDEO CALIBRATION	ON
PICTURE CONTROL	AUTO
DIGITAL TBC/NR	ON
VIDEO STABILIZER	OFF
NEXT PAGE	
SELECT WITH (▲, ▼) AND (OK)	
PRESS (MENU) TO END	



PREVIOUS PAGE	
→ DIGITAL R3	ON
AUTO SP→EP TIMER	OFF
SELECT WITH (▲, ▼) AND (OK)	
PRESS (MENU) TO END	

4 RETURN TO NORMAL SCREEN

Press MENU.

NOTES:

- Normally it is recommendable to keep "DIGITAL R3" set to "ON".
- Depending on the type of tape being used, picture quality may be better with "DIGITAL R3" set to "OFF".
- If you use this VCR as the player for editing, be sure to set "DIGITAL R3" to "OFF" before starting.

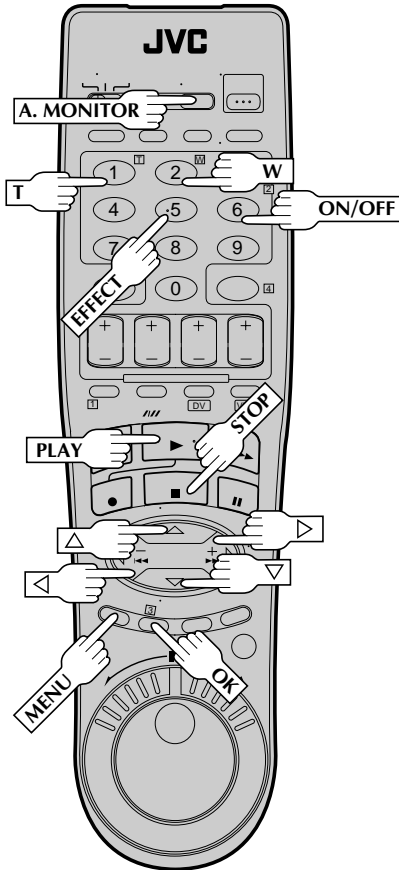
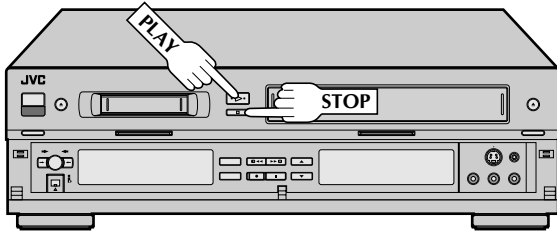

Zoom (DV Deck Only)

This function allows you to zoom in on a portion of the screen during playback.

1 ZOOM DURING PLAYBACK

Press **T** to zoom in on an image during playback. Press **W** to zoom out.

2 MOVE SCREEN

After zooming in, use $\Delta \nabla \leftarrow \rightarrow$ to move the screen up, down, left, or right.

3 STOP ZOOM

To leave the zoom view and return to the normal screen, press **W**. Another method is to press **STOP**, and then press **PLAY**.

Playback Effects (DV Deck Only)

This function allows you to temporarily insert playback effects on the screen during playback. Because these effects are not recorded on the tape, you will only see the original image when you play back the tape next time.

1 ACTIVATE PLAYBACK EFFECT

Press **EFFECT** repeatedly (within two seconds) to select the desired playback effect (refer to the chart below).

1	--
2	
3	B/W
4	
5	
6	

2 STOP PLAYBACK EFFECT

Press **ON/OFF** to turn off the playback effect. Pressing **ON/OFF** again causes the selected playback effect to re-appear.

MENU ICON	EFFECT
--	Select when you do not want to use any playback effects.
 CLASSIC FILM	Select when you want to add a movie-like effect to the playback by omitting frames.
B/W MONOTONE	Select when you want the playback to be in black & white.
 SEPIA	Select when you want to add a sepia tone to the playback so that it resembles an old photograph.
 STROBE	Select when you want to add a strobe light effect so that the playback resembles a series of fast, discrete still images.
 VIDEO ECHO	Select when you want to add ghosting to the video to create a dream-like effect.

NOTE:

Playback Effect does not work when dubbing from the VHS deck to the DV deck.

Select The Soundtrack (DV deck)

The DV deck can record two soundtracks simultaneously (L and R) and play back the selected one, or both together. Or, when viewing a pre-recorded tape that contains two separate audio programs, you can choose to listen to either one by selecting either "L" or "R".

You can select the soundtrack by simply pressing the remote control's **A. MONITOR** button as follows:

L+R → L → R → L+R

Sound Mode Selection (DV deck only)

1

ACCESS MAIN MENU SCREEN

Press **MENU**.

2

ACCESS DV MODE SET SCREEN

Move the highlight bar (arrow) to "DV MODE SET" by pressing **CH▲▼** or **△▽**, then press **OK** or **▷**.

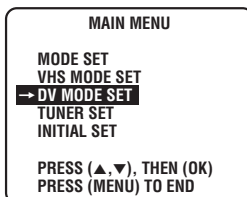

3

SELECT SOUND MODE

Move the highlight bar (arrow) to "SOUND MODE" by pressing **CH▲▼** or **△▽**, then press **OK** or **▷** to select "32kHz" or "48kHz".

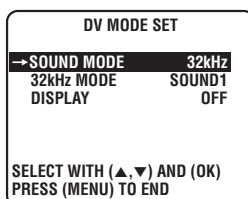

4

RETURN TO NORMAL SCREEN

Press **MENU**.

NOTE:

Set "SOUND MODE" to "32kHz" at the original recording on a Mini DV tape, if you wish to perform Audio Dubbing later.

32kHz Mode Setting (Audio-dubbed Mini DV Tape)

1

ACCESS MAIN MENU SCREEN

Press **MENU**.

2

ACCESS DV MODE SET SCREEN

Move the highlight bar (arrow) to "DV MODE SET" by pressing **CH▲▼** or **△▽**, then press **OK** or **▷**.

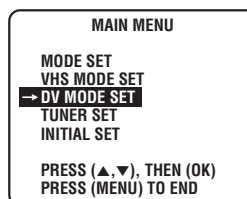

3

SELECT 32kHz MODE

Move the highlight bar (arrow) to "32kHz MODE" by pressing **CH▲▼** or **△▽**, then press **OK** or **▷** to select "SOUND1", "SOUND2" or "FULL SOUND".

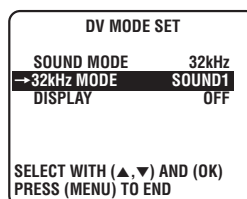

4

RETURN TO NORMAL SCREEN

Press **MENU**.

32kHz MODE	SOUND YOU HEAR
SOUND1	Original recorded sound
SOUND2	Audio-dubbed sound
FULL SOUND	Original recorded sound and Audio-dubbed sound

NOTES:

When "32kHz MODE" is set to "FULL SOUND":

- For bilingual tapes, both the main and sub audio will be audible.
- To select just the main audio or just the sub audio of Bilingual tapes, set "32kHz MODE" to "SOUND1".

Active Video Calibration

(VHS deck only)

Turn on the TV and select the AV mode.

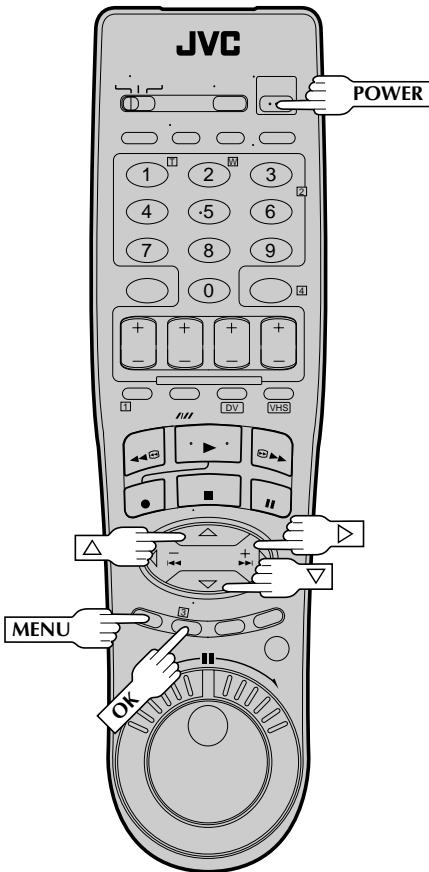
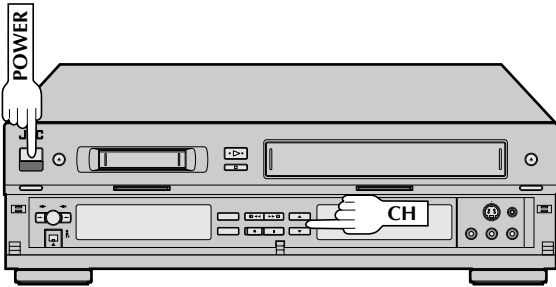

Active Video Calibration checks the condition of the tape during recording and playback, and compensates for poor reproduction to provide the best quality recording and playback pictures. *The default setting is "ON".

Preparation

1 TURN ON THE VCR

Press **POWER**.

2 ACCESS MAIN MENU SCREEN

Press **MENU**.

3 ACCESS VHS MODE SET SCREEN

Press **CH▲▼** or **▲▼** to move the highlight bar (arrow) to "VHS MODE SET", then press **OK** or **▷**.

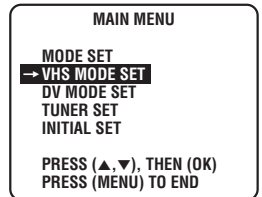

4 SELECT VIDEO CALIBRATION MODE

Press **CH▲▼** or **▲▼** to move the highlight bar (arrow) to "VIDEO CALIBRATION", then press **OK** or **▷** to set to "ON" or "OFF".

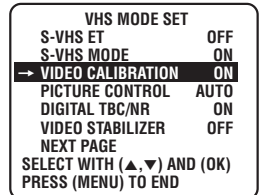

NOTE:

When recording or when playing back tapes recorded on this VCR set the Video Calibration to "ON".

5 RETURN TO NORMAL SCREEN

Press **MENU**.

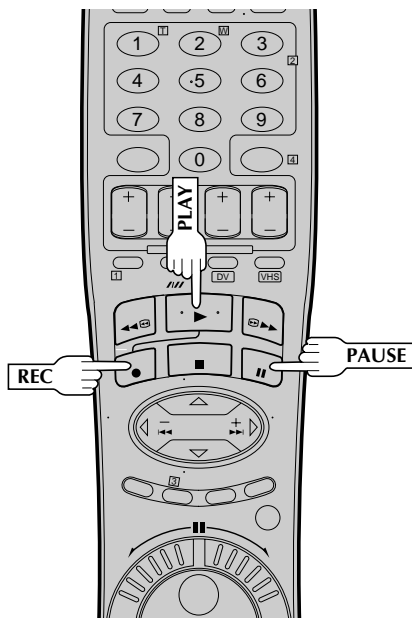
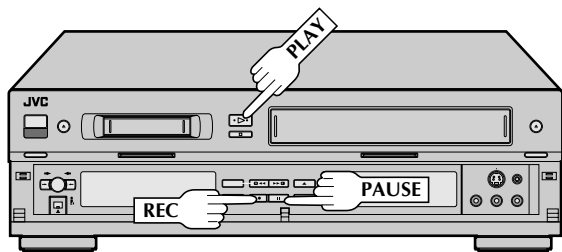

Recording

Perform steps 1 – 4 on page 22 ("Simple Recording") before continuing.

1

START RECORDING

Press and hold **REC** and press **PLAY** on the remote control, or press **REC** on the VCR's front panel.

- The VCR takes about 7 seconds to assess the quality of the tape in use, then recording begins with the picture level optimized.

DURING CALIBRATION

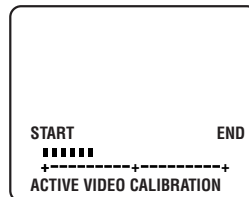

CALIBRATION COMPLETE

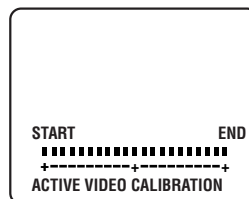

NOTES:

- Calibration occurs immediately prior to both the first SP and the first EP recording after inserting the cassette. It does not take place during recording.
- In the case of timer recording, calibration takes place for both SP and EP before the first timer recording after inserting the cassette (regardless of the tape speed selected for that recording).
- Once the cassette is ejected, the calibration data is canceled. The next time the cassette is used for recording, calibration is re-performed.
- While Video Calibration is operative, the **PAUSE** button will not function.
- To display the Video Calibration screen, "SUPERIMPOSE" must be set to "ON" or the Video Calibration screen will not appear (☞ pg. 25).

Playback

The VCR assesses the quality of the tape once you start playback.

Perform steps 1 – 3 on page 21 ("Simple Playback") before continuing.

1

START PLAYBACK

Press **PLAY**.

- The VCR adjusts the playback picture quality based on the quality of the tape in use.

—VIDEO CALIBRATION—

NOTES:

- When using rental tapes, or tapes recorded on other VCRs, set "VIDEO CALIBRATION" in step 4 of the Preparation procedure to either "ON" or "OFF" as desired to give the best picture (☞ pg. 34).
- The Video Calibration screen only appears at the beginning of automatic tracking. Even though the screen doesn't appear after that, the Video Calibration function is operative.
- To display the Video Calibration screen, "SUPERIMPOSE" must be set to "ON" or the Video Calibration screen will not appear (☞ pg. 25).

ATTENTION

- As calibration takes place before recording actually starts, there is a delay of about 7 seconds after **REC** and **PLAY** on the remote, or **REC** on the VCR's front panel, are pressed. To make sure you record the desired scene or program completely, first perform the following steps:
 - 1) Press and hold **PAUSE**, and press **REC** to engage the RECORD PAUSE mode.
 - The VCR then automatically checks the condition of the tape and, after about 7 seconds, re-enters RECORD PAUSE.
 - 2) Press **PLAY** to start recording.
- If you want to bypass Video Calibration and start recording right away, set "VIDEO CALIBRATION" to "OFF" in step 4 of the Preparation procedure (☞ pg. 34).

Recording Features

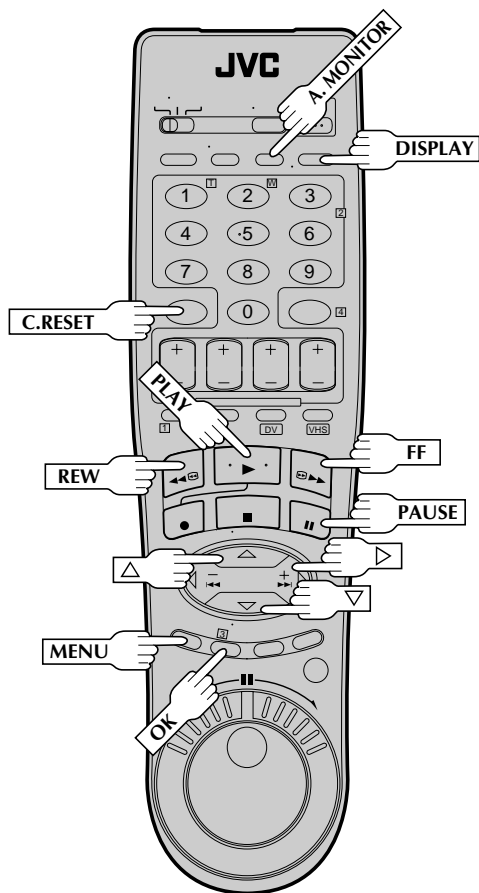

Record One Program While Watching Another

1

ENGAGE TV MODE

During recording...

- Change the TV's input mode from AV to TV.

2

SELECT CHANNEL FOR VIEWING

Use the TV's channel selector to set the channel you want to watch.

Display Elapsed Recording Time (VHS deck only)

1

RESET COUNTER TO ZERO

Before recording starts, press **C.RESET**. The counter resets to zero and displays the exact elapsed time as the tape runs.

2

DISPLAY ELAPSED TIME ON SCREEN

During recording, press **DISPLAY** at any time to see the elapsed time.

All indications corresponding to the current status of the VCR are displayed for 5 seconds. The counter display remains on the screen indicating the elapsed time. Press **DISPLAY** again to remove the display.

- Make sure "SUPERIMPOSE" is set to "ON" (☞ pg. 25).
- The indications are not recorded.
- Press **DISPLAY** to change to the COUNT display if "REMAIN" is displayed.

Display Tape Remaining Time (VHS deck only)

1

DISPLAY COUNTER INFORMATION

Press **DISPLAY**.

All indications corresponding to the VCR's current status are displayed for 5 seconds. The counter display remains on the screen indicating the elapsed time.

2

DISPLAY TAPE REMAINING TIME

Press **DISPLAY** repeatedly until "REMAIN" appears on screen. The approximate tape remaining time appears on the TV screen and also on the VCR display panel with a "▶" indicator.

- The tape remaining time is calculated based on the tape speed (SP or EP) being used. The indicated remaining time is only an estimate.
- Press **DISPLAY** to change the on-screen display from "REMAIN" to "COUNT" and vice versa; and to show counter reading, channel number, clock time or tape remaining time on the front display panel. Then channel number will not be displayed when the VCR is playing a tape.

3

EXIT THE DISPLAY

Press **DISPLAY** again.

NOTES:

- "SUPERIMPOSE" must be set to "ON", or the on-screen display will not appear (☞ pg. 25).
- Near the beginning of the tape, the tape remaining estimate may be inaccurate. However, the estimate becomes more accurate as the tape comes closer to the end.
- Depending on the type of tape used, the tape remaining time reading may not appear right away, or may not be correct. "-: -:" may sometimes appear, or the display may blink on occasion.
- The tape remaining time indication is not accurate when using VHS-C tapes with VHS-C adapter.

Stereo And SAP (Second Audio Program)

Your VCR's built-in MTS decoder enables reception of Multi-channel TV Sound broadcasts.

When the channel is changed on the VCR ...

- The "STEREO" indication appears on the screen for about 5 seconds if the program is a stereo broadcast.
- The "SAP" indication appears on the screen for about 5 seconds if the program is a SAP broadcast.
- Both indications appear when a stereo program is accompanied by SAP audio.

To Record Stereo Programs . . .

. . . simply follow the basic recording procedure.

To Listen To Stereo Soundtrack During Recording . . .

. . . press **A. MONITOR** to select "HI-FI" (☞ pg. 29).

To Record SAP Programs . . .

1

ACCESS MAIN MENU SCREEN

Press **MENU**.

2

ACCESS MODE SET SCREEN

Move the highlight bar (arrow) to "MODE SET" by pressing **CH▲▼** or **Δ▽**, then press **OK** or **▷**.

3

SELECT 2ND AUDIO RECORD SET MODE

Move the highlight bar (arrow) to "2ND AUDIO RECORD" by pressing **CH▲▼** or **Δ▽**, then press **OK** or **▷** to set to "ON".

MODE SET	
REAR AUX INPUT	VIDEO
FRONT AUX INPUT	VIDEO
OUTPUT1	AUTO
→ 2ND AUDIO RECORD	ON
AUTO TIMER	OFF
SUPERIMPOSE	ON

SELECT WITH (▲, ▼) AND (OK)
PRESS (MENU) TO END

4

RETURN TO NORMAL SCREEN

Press **MENU**.

NOTES:

- If a SAP program is received and "2ND AUDIO RECORD" is set to "ON", the SAP audio is recorded on both the Normal and Hi-Fi tracks. The main audio program is not recorded.
- If a non-SAP program is received, the main audio is recorded on both the Hi-Fi and Normal audio tracks.

Retake (VHS deck only)

You can cut out unnecessary parts of a TV program while you're recording it.

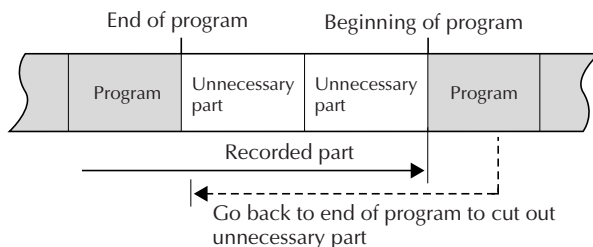

1

ENGAGE RECORD-PAUSE MODE

Press **PAUSE** during recording.

2

LOCATE START POINT

Hold down **REW** or **FF** and release it when you reach the point where you want to resume recording.

* Your recorder returns to the Record-Pause mode.

3

RESUME RECORDING

Press **PLAY** when you wish to resume recording.

Accidental erasure prevention

• VHS/S-VHS

To prevent accidental recording on a recorded cassette, remove its safety tab. To record on it later, cover the hole with adhesive tape.

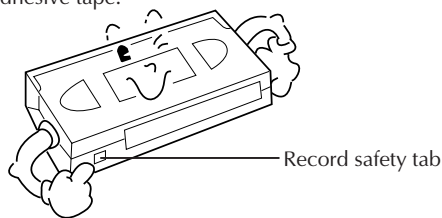

• Mini DV

To prevent accidental recording on a recorded cassette, set its erase protection switch to "SAVE". To record on it later, set the switch to "REC".

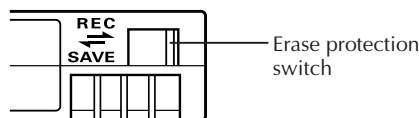

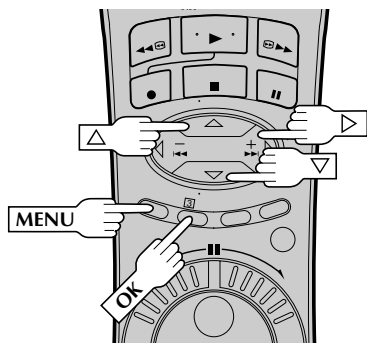
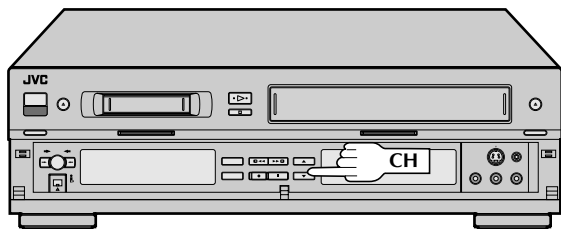

S-VHS (Super VHS), S-VHS ET and VHS (VHS deck only)

Your VCR can record in S-VHS, S-VHS ET or VHS.

S-VHS allows you to make high quality video recordings with a horizontal resolution of 400 lines. This compares with the 240 lines of resolution of normal VHS recordings. To achieve the highest quality picture we recommend that you record in S-VHS mode.

By using S-VHS ET it is possible to record and play back with S-VHS picture quality on VHS cassettes with this VCR. For details, refer to page 39.

To record in S-VHS;

- perform the steps 1 – 4 below to set the "S-VHS MODE" to "ON".
 - then, insert a cassette marked "S-VHS", the S-VHS indicator will light on the display panel.
- The S-VHS recording mode will be automatically selected.

To record in S-VHS ET on a VHS high grade cassette;

- press **S-VHS ET** and set to "ON".
- ☞ "Super VHS ET" on page 39.

To record in VHS;

- insert a cassette marked "VHS".
 - press **S-VHS ET** and set to "OFF".
- The VHS recording mode will be automatically selected regardless of the S-VHS mode setting.

To record in VHS on an S-VHS cassette;

- insert the cassette marked "S-VHS", the S-VHS indicator will light on the display panel.
 - then, perform the steps 1 – 4 below to set the "S-VHS MODE" to "OFF"; the S-VHS indicator will go out.
- The VHS recording mode will be selected.

NOTE:

Tapes recorded in S-VHS or S-VHS ET mode can not be played back successfully on normal VHS VCRs.

ACCESS MAIN MENU SCREEN

Press **MENU**.

ACCESS VHS MODE SET SCREEN

Move the highlight bar (arrow) to "VHS MODE SET" by pressing **CH▲▼** or **▲▼**, then press **OK** or **▷**.

SELECT S-VHS MODE

Move the highlight bar (arrow) to "S-VHS MODE" by pressing **CH▲▼** or **▲▼**, then press **OK** or **▷** to set to "ON" or "OFF".

VHS MODE SET	
S-VHS ET	OFF
S-VHS MODE	ON
VIDEO CALIBRATION	ON
PICTURE CONTROL	AUTO
DIGITAL TBC/NR	ON
VIDEO STABILIZER	OFF
NEXT PAGE	
SELECT WITH (▲, ▼) AND (OK)	
PRESS (MENU) TO END	

RETURN TO NORMAL SCREEN

Press **MENU**.

NOTE:

When playing back a tape that has been recorded in S-VHS or S-VHS ET, the S-VHS indicator lights on the display panel regardless of the "S-VHS MODE" setting.

Super VHS ET (VHS deck only)

Your VCR is equipped with Super VHS ET that makes it possible to record with S-VHS picture quality on VHS cassettes.

- 1 **ACCESS MAIN MENU SCREEN**
Press **MENU**.
- 2 **ACCESS VHS MODE SET SCREEN**
Move the highlight bar (arrow) to "VHS MODE SET" by pressing **CH▲▼** or **▲▼**, then press **OK** or **▷**.
- 3 **SELECT S-VHS ET MODE**
Move the highlight bar (arrow) to "S-VHS ET" by pressing **CH▲▼** or **▲▼**, then press **OK** or **▷** to set to "ON" or "OFF".
- 4 **RETURN TO NORMAL SCREEN**
Press **MENU**.

VHS MODE SET	
→ S-VHS ET	ON
S-VHS MODE	ON
VIDEO CALIBRATION	ON
PICTURE CONTROL	AUTO
DIGITAL TBC/NR	ON
VIDEO STABILIZER	OFF
NEXT PAGE	
SELECT WITH (▲, ▼) AND (OK)	
PRESS (MENU) TO END	

S-VHS ET

This facility allows recording with S-VHS picture quality on VHS cassettes. You can play back those cassettes recorded in S-VHS ET on a VCR equipped with S-VHS ET.

NOTES:

- To obtain the highest quality recording and playback pictures over a longer period on this model, S-VHS recording on S-VHS tape is recommended.
- You can play back S-VHS ET recordings not only on this VCR but also on another VHS VCR equipped with S-VHS ET.
* It is recommended to specifically label S-VHS ET recordings so you can easily distinguish them from regular VHS recordings.
- S-VHS ET recordings can also be played back on an S-VHS VCR or a VHS VCR equipped with SQPB (S-VHS QUASI PLAYBACK) function. However, there may be cases where S-VHS ET playback is not possible on a particular VCR.
- Frequent still, frame-by-frame and slow-motion playback may damage the tape and cause picture degradation.
- With some tapes, better picture quality may not be obtained even with S-VHS ET recording. It is recommended that you do test record beforehand to make sure whether better results can be obtained.
- High Grade tapes are recommended for superior results.
- Make sure that "VIDEO CALIBRATION" is set to "ON" at the Function screen (☞ pg. 34).
- During S-VHS ET playback, noise may appear depending on tape quality.
- Noise may appear during still, frame-by-frame and slow-motion playback.
- If the playback picture becomes blurred or interrupted, use a cleaning cassette.

NOTES:

- You cannot activate the S-VHS ET function...
...while recording is in progress.
...while timer-recording (incl. Instant Timer Recording ☞ pg. 49) is in progress.
...while Video Calibration (☞ pg. 34) is in progress.
...when the VCR's power is off.
- S-VHS ET does not work with S-VHS tapes.

VCR Plus+® Timer Programming

Turn on the TV and select the AV mode.

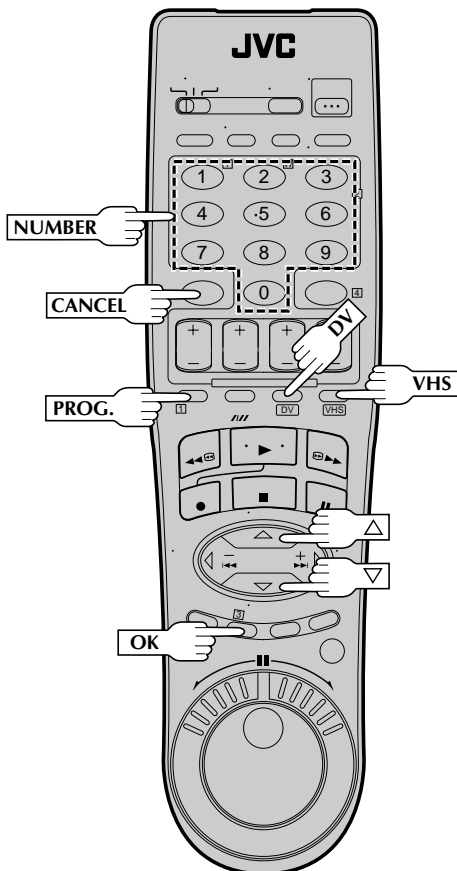
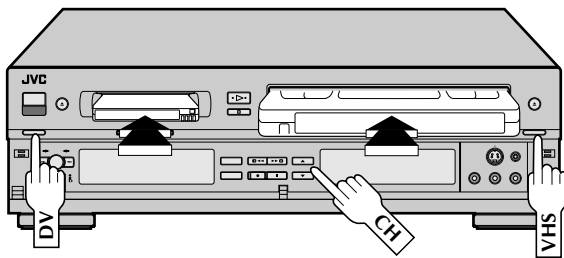

Timer recording allows you to program the VCR to automatically record a program that will be broadcast at some future time. The timer record function can be programmed using the VCR Plus+ or Express Timer programming up to 6 shows each on the VHS and DV decks as far as a year in advance. (☞ pg. 40 or 44) The VCR Plus+ timer programming system eliminates the need to input channel, date, start and stop time data when setting the timer record function. Simply key in the PlusCode number for the TV program you wish to record and the VCR's timer will be automatically programmed. (The PlusCode programming numbers are the numbers next to the program in most TV listing.)

1

LOAD A CASSETTE

Insert a VHS (or S-VHS) cassette with the record safety tab intact, or a Mini DV cassette with the erase protection switch set to "REC".

- The VCR's power comes on automatically.
- Select the recording deck by pressing **VHS** or **DV**.

2

ACCESS VCR PLUS+ SCREEN

Press **PROG.** on the remote control.

- The clock must be set in order to access the VCR Plus+ screen. If you haven't set the clock, the Main Menu screen appears after an error message is displayed.

Refer to page 8 for the Plug & Play procedure or page 10 for the clock setting procedure.

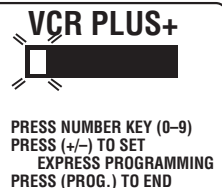

3

ENTER PLUSCODE NUMBER

Press the appropriate **NUMBER** keys to enter the PlusCode number printed in the TV listings for the TV program you wish to record and press **OK**.

If the Guide Channel Set screen appears, go to step 4.
If the VCR Plus+ program screen appears, go to step 5.

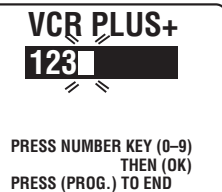

- To make corrections, press **CANCEL** and input the correct PlusCode number.

4

INPUT RECEIVING CHANNEL NUMBER

The Guide Channel Number, which is assigned to the TV or cable station for the PlusCode number that you entered in step 3, will appear automatically on the Guide Channel Set screen. Input the number of the channel on which the broadcast for the PlusCode number is received on the VCR or cable box using the **NUMBER** keys, **CH ▲▼** or **Δ▽**, then press **OK**.

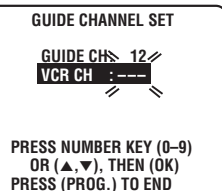

- The Guide Channel Set screen appears only when you input the PlusCode number of a station for which the Guide Channel number has not previously been set.
- If you receive your channels with a cable box and if you have properly set your Controller, "CABLE CH" appears in place of "VCR CH". If not, refer to pages 15 - 17.

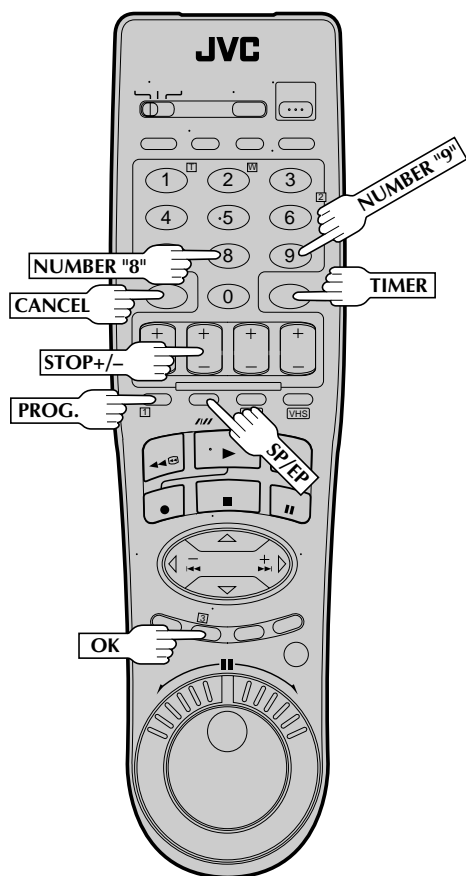

ATTENTION

If there is a conflict in the timer schedule and one program overlaps with another, only the parts shown below in gray will be recorded.

Pattern 1: The program with the lower program number will be recorded.

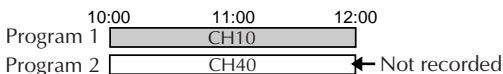

Pattern 2: The program that is broadcast earlier will be recorded.

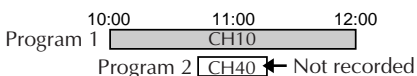

Pattern 3: The program that is broadcast earlier will be recorded, followed by the remaining portion of the other program.

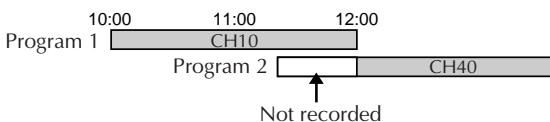

5

CHECK PROGRAM DATA

The PlusCode number you entered and the matching Timer-Recording information is displayed on the Program screen. Check to make sure it's accurate.

VHS	PROGRAM 1
	(VCR PLUS+ 12345678)
START	STOP
8:00PM →	10:00PM
DATE	CH
12/24/00	12 SP
THU	
PRESS (8=DAILY, 9=WEEKLY	
STOP +/- = STOP TIME, SP/EP	
PRESS (OK) TO END	

- To change the stop time, press **STOP +/-**.
- To timer-record daily or weekly serials, press **DAILY** (NUMBER key "8") or **WEEKLY** (NUMBER key "9"). "DAILY" or "WEEKLY" appears on the Program screen. Pressing the button again makes each corresponding display disappear.
- If you made a mistake, press **CANCEL** to access the VCR Plus+ screen again and input the correct PlusCode number.
- If the PlusCode number you inputted is incorrect, "ERROR" may appear on the screen to advise you of the error. This happens when the PlusCode number is for a program which has already passed. "ERROR" is displayed for about 5 seconds and the VCR Plus+ screen reappears.

SET TAPE SPEED

Press **SP/EP** (SP/LP for the DV deck).

6

RETURN TO NORMAL SCREEN

Press **PROG.** or **OK**. "PROGRAM COMPLETED" appears on the screen for about 5 seconds, then normal screen appears.

7

ENGAGE TIMER MODE

Press **TIMER**. The VCR turns off automatically and "⊕" is displayed on the display panel.

8

IMPORTANT

If you have moved to a different area or if a broadcasting station's channel number has been changed, the wrong VCR or CABLE CH number will be displayed on the VCR Plus+ program screen in step 5. When this happens, set the correct the Guide Channel number for that station. (☞ pg. 42, "Changing VCR Plus+® Setting")

NOTES:

- To disengage the timer before recording starts, press **TIMER** again. Pressing once more re-engages it.
- In case of a power failure after programming, the VCR's memory backup keeps your selections for approximately 10 minutes.
- When timer-recording cable channels received through a Cable Box, be sure to keep the Cable Box set to ON.
- It is not possible to timer-record the same programme on both the VHS deck and the DV deck simultaneously.
- If the times that are programmed for recording on the DV deck and on the VHS deck overlap, the earlier start time takes precedence. If the start times are the same, the VHS deck takes precedence.

Changing VCR Plus+[®] Setting

Turn on the TV and select the AV mode.

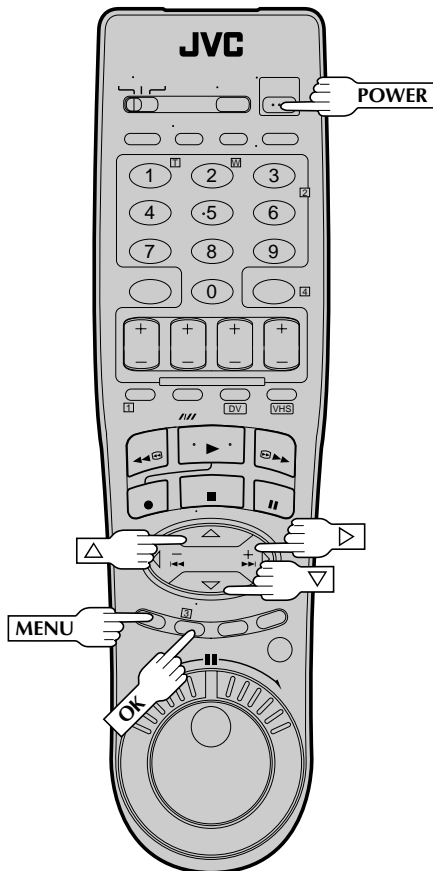
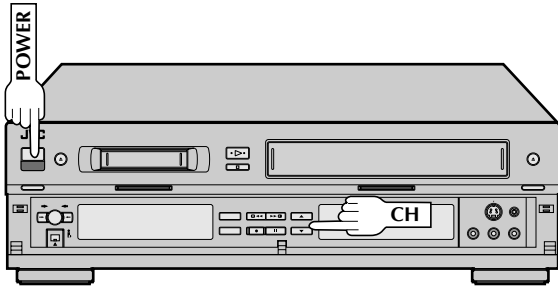

IMPORTANT

If you have moved to a different area or if a broadcasting station's channel number has been changed, the wrong VCR or CABLE CH number will be displayed on the VCR Plus+ program screen (see step 5 on page 41). When this happens, perform the following steps to set the correct the Guide Channel number for that station.

To ensure that the VCR Plus+Timer Recording operates correctly it is necessary to set the VCR Plus+ "Guide Channel Set " for each station. Please read the following information carefully.

VCR Plus+ Guide Channel Matching

VCR Plus+ programming system assigns a VCR Plus+ "Guide Channel" to broadcast and cable TV channels. These Guide Channel numbers are also called the VCR Plus+ Channel Codes. Most TV listings have a section, usually a chart, indicating the "Guide Channel" numbers assigned to each station. For accurate VCR Plus+ programming the VCR Plus+ Guide Channel number for each station should match the channel number on which it is received in your area.

NOTES:

- In many instances the VCR Plus+ Guide Channel numbers for cable and broadcast TV stations **DO NOT** match the channel number on which it is received by your VCR or cable box. Check your TV listing, or contact your cable supplier for details.
- Many broadcast TV stations can be viewed on cable. Check your TV listing, or contact your cable supplier for details.

1 TURN ON THE VCR

Press **POWER**.

2 ACCESS MAIN MENU SCREEN

Press **MENU**.

3 ACCESS INITIAL SET SCREEN

Press **CH▲▼** or **▲▼** to move the highlight bar (arrow) to "INITIAL SET", then press **OK** or **▷**.

MAIN MENU

MODE SET
VHS MODE SET
DV MODE SET
TUNER SET
→ INITIAL SET

PRESS (▲, ▼), THEN (OK)
PRESS (MENU) TO END

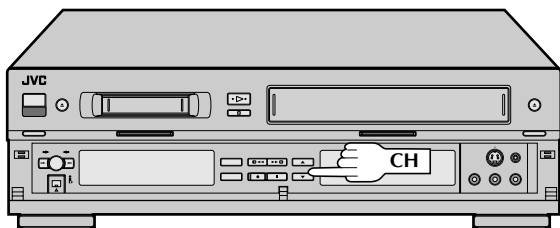

4

ACCESS GUIDE CHANNEL SET SCREEN

Press **CH**▲▼ or ▲▼ to move the highlight bar (arrow) to "GUIDE CHANNEL SET", then press **OK** or ▷.

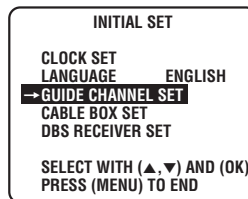

INPUT GUIDE CHANNEL NUMBER

Press **CH**▲▼, ▲▼ or the appropriate **NUMBER** keys to input the VCR Plus+ Guide Channel number as shown in the TV listing. Then press **OK** or ▷.

(Ex.) When inputting the Guide Channel number 6 for WNJU(Ind.)

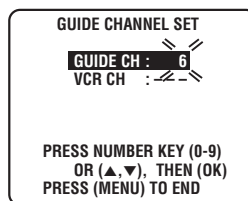

- If you receive your channels with a cable box and if you have properly set your Controller, "CABLE CH" appears in place of "VCR CH". If not, refer to pages 15 – 17 and re-perform the procedure.

INPUT RECEIVING CHANNEL NUMBER

Press **CH**▲▼, ▲▼ or the appropriate **NUMBER** keys to input the number of the channel on which the Guide Channel's broadcasts are received. Then press **OK** or ▷.

(Ex.) If WNJU(Ind.) is received on channel 47

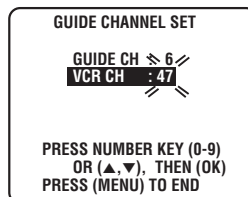

- Repeat steps 5 and 6 for each instance.

RETURN TO NORMAL SCREEN

Press **MENU**.

7

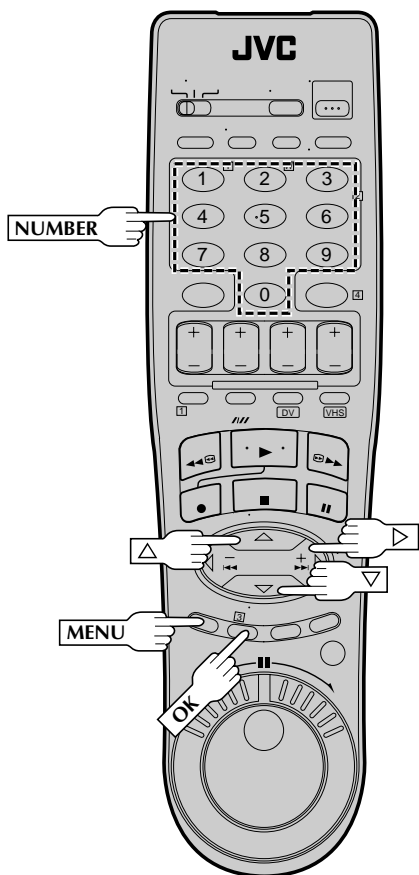

Express Timer Programming

Turn on the TV and select the AV mode.

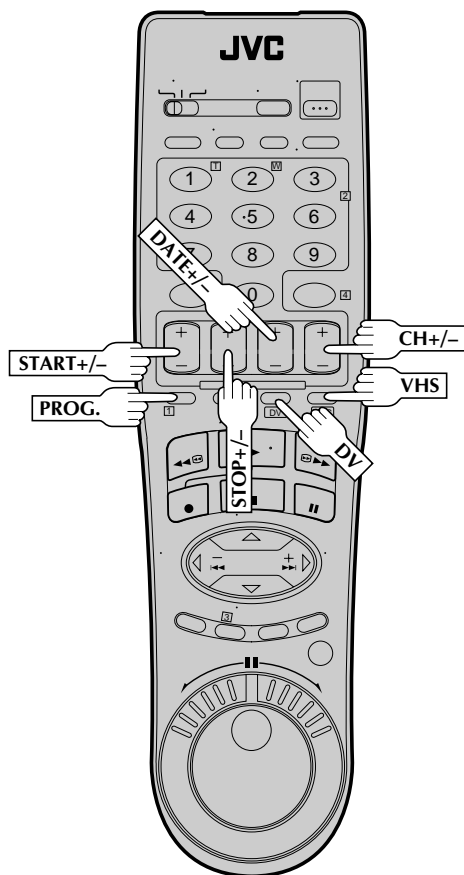
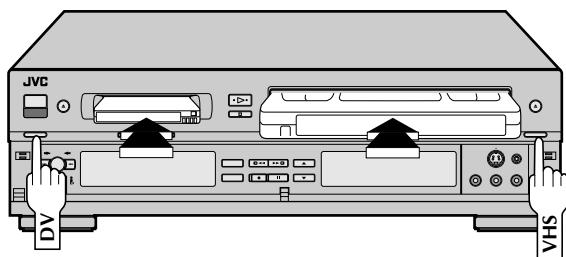

You can directly program the VCR's timer to record up to 6 shows each on the VHS and DV decks, as far as a year in advance. Remember, the clock must be set before you can program the timer (pg. 8 or 10).

1

LOAD A CASSETTE

Insert a VHS (or S-VHS) cassette with the record safety tab intact, or a Mini DV cassette with the erase protection switch set to "REC".

- The VCR comes on, and the counter is reset, automatically.
- Select the recording deck by pressing **VHS** or **DV**.

2

ACCESS VCR PLUS+ SCREEN

Press **PROG.**

3

ACCESS PROGRAM SCREEN

Press **START +/-**. (If you're just starting out, "PROGRAM 1" appears.)

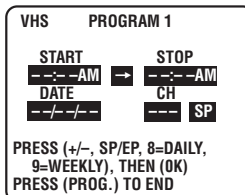

4

SET PROGRAM START TIME

Press **START +/-** to enter the time you want recording to start.

- Press and hold **START +/-** to move in 30-minute increments, or press and release repeatedly to move 1 minute at a time.

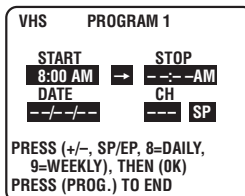

5

SET PROGRAM STOP TIME

Press **STOP +/-** to enter the time you want recording to stop.

- Press and hold **STOP +/-** to move in 30-minute increments, or press and release repeatedly to move 1 minute at a time.

6

SET PROGRAM DATE

Press **DATE +/-**. (The current date is displayed on screen. The date you enter appears in its place.)

7

SET CHANNEL NUMBER

Press **CH +/-**.

- If you are using a DBS receiver, see "ATTENTION FOR DBS RECEIVER USERS" on next page.
- Holding down **CH +/-** rapidly scans through the channels.

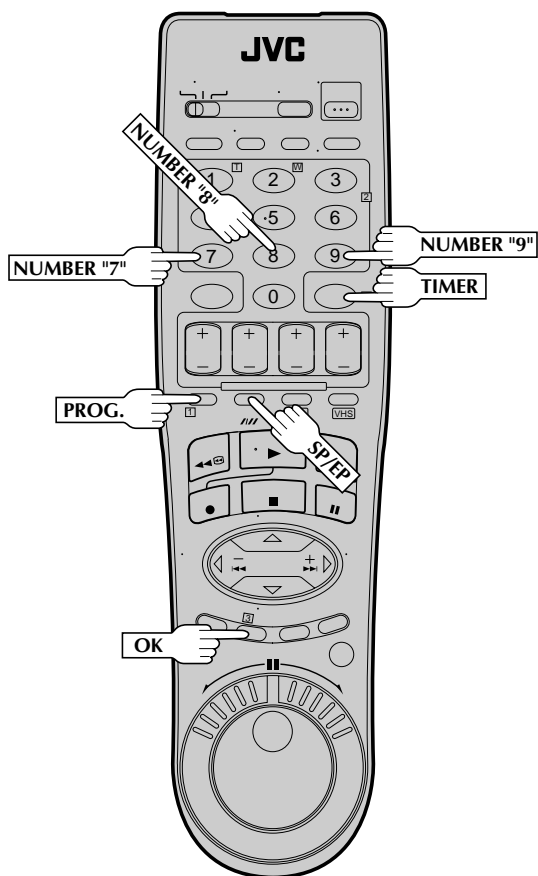

8 SET TAPE SPEED

Press **SP/EP** (SP/LP for the DV deck) to set the tape speed.

9 RETURN TO NORMAL SCREEN

Press **PROG.** or **OK**. "PROGRAM COMPLETED" appears on the screen for about 5 seconds, then normal screen appears.

10 ENGAGE TIMER MODE

Press **TIMER**. The VCR turns off automatically and "⊕" is displayed on the display panel.

- When "AUTO TIMER" is set to "ON" (pg. 48), press **POWER**.

To Timer-Record Weekly Or Daily Serials . . .
 . . . anytime during steps 3 through 9, press **WEEKLY** (NUMBER "9") for weekly serials or **DAILY** (NUMBER "8") for daily serials (Monday–Friday). Either "WEEKLY" or "DAILY" appears on the screen. Pressing the button again makes the corresponding indication disappear.

NOTES:

- To disengage the timer before recording starts, press **TIMER** again. Pressing once more re-engages it.
- In case of a power failure after programming, the VCR's memory backup keeps your selections for approximately 10 minutes.
- Programs that start after midnight must have the next day's date.
- After timer recording is completed, the VCR's power goes off automatically.
- You can program the timer while a regular recording is in progress; the on-screen menu will not be recorded.
- If the end of tape is reached during timer recording, the cassette is automatically ejected.
- When timer-recording cable or satellite channels through an external tuner, be sure to keep the cable box or satellite receiver's power ON.

ATTENTION FOR DBS RECEIVER USERS

If you are using a DBS receiver (unless "DBS RECEIVER SET" is set to "OFF" pg. 19), the BAND indication (TV or CATV or DBS) appears under the channel number display. If the channel number that has been entered requires that the band be set, "7=DBS" is displayed on the screen. Press the **NUMBER** key "7" to select the desired band.

VHS		PROGRAM 1	
START	STOP		
8:00AM	9:00PM		
DATE	CH		
12/24/00	110	SP	
THU	DBS		
PRESS (+/-, SP/EP, 8=DAILY, 9=WEEKLY, 7=DBS), THEN (OK) PRESS (PROG.) TO END			

- a- TV : To timer-record a regular TV program received on the VCR.
 - b- CATV : To timer-record a cable TV program received on the VCR, or through a cable box (unless "CABLE BOX SET" is set to "OFF" pg.16).
 - c- DBS : To timer-record a satellite program received through a DBS receiver.
- If "BAND" is set to "TV" at the Tuner Set screen (pg.13) and "CABLE BOX SET" is set to "OFF" at the Cable Box Set screen (pg. 16), CATV will not be displayed on the Program screen; If "BAND" is set to "CATV" or "CABLE BOX SET" is set to "ON", TV will not be displayed.

ATTENTION

If there is a conflict in the timer schedule and one program overlaps with another, only the parts shown below in gray will be recorded.

Pattern 1: The program with the lower program number will be recorded.

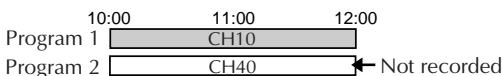

Pattern 2: The program that is broadcast earlier will be recorded.

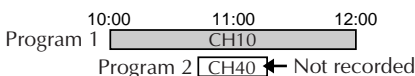

Pattern 3: The program that is broadcast earlier will be recorded, followed by the remaining portion of the other program.

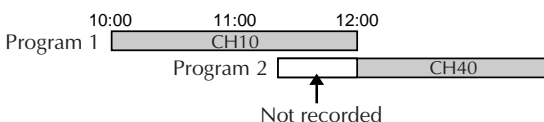

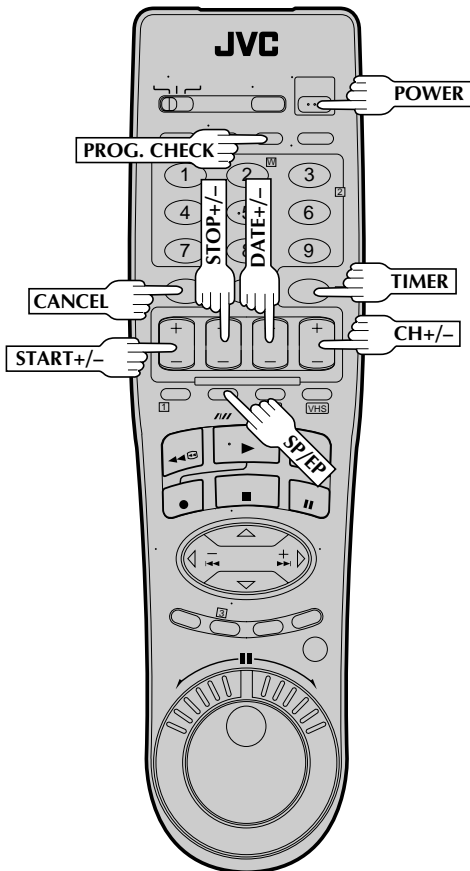
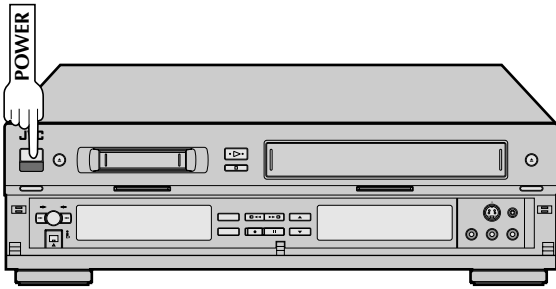

Check, Cancel And Revise Programs

1 DISENGAGE TIMER

Press **TIMER**, then press **POWER**.

2 ACCESS PROGRAM CHECK SCREEN

Press **PROG. CHECK**.

VHS	PR	START	STOP	CH	DATE
	1	8:00P	10:00	12	12/24
	2	10:00A	10:45	40	12/25
	3	11:30P	1:00	125	12/25
	4				
	5				
	6				

PRESS (CHECK) TO NEXT

3 ACCESS PROGRAM SCREEN

Press **PROG. CHECK** again to check more information. Each time you press **PROG. CHECK**, the next program's information appears.

To Cancel Or Revise A Program...

4 CANCEL OR REVISE A PROGRAM

To cancel a program, press **CANCEL** at the appropriate program screen.

To revise a program, press the appropriate button: **START+/-**, **STOP+/-**, **DATE+/-**, **CH+/-**, **SP/EP**.

5 RETURN TO NORMAL SCREEN

Press **PROG. CHECK** as many times as necessary. If there are still programs remaining, go to step 6.

6 RE-ENGAGE TIMER

Press **TIMER**.

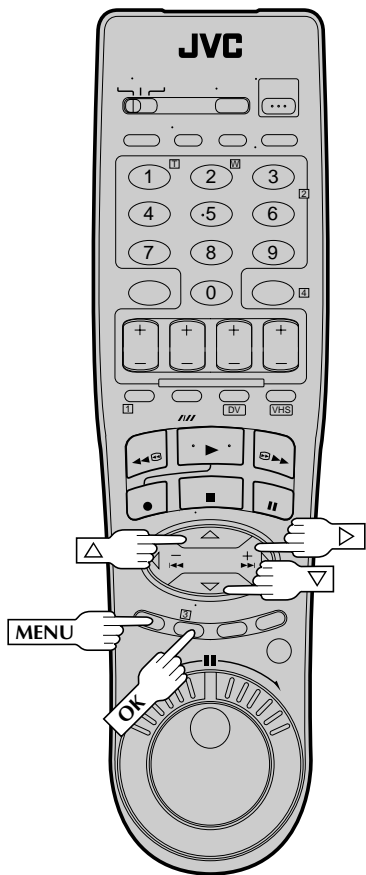
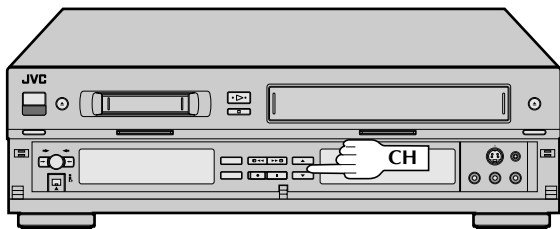

Auto SP→EP Timer (VHS deck only)

If, when recording in SP mode, there is not enough tape to record the entire program, the VCR automatically switches to EP mode to allow complete recording. This feature is especially handy when recording a program of more than 2 hours in length.

For Example . . .

Recording a program of 140 minutes in length onto a 120-minute tape

Approximately 110 minutes	Approximately 30 minutes
SP mode	EP mode
Total 140 minutes	

Make sure you set "AUTO SP→EP TIMER" to "ON" at the VHS Mode Set screen before the timer recording starts.

1 ACCESS MAIN MENU SCREEN

Press MENU.

2 ACCESS VHS MODE SET SCREEN

Move the highlight bar (arrow) to "VHS MODE SET" by pressing CH ▲▼ or Δ∇, then press OK or ▷.

3 SELECT AUTO SP→EP TIMER SET MODE

Move the highlight bar (arrow) to "AUTO SP→EP TIMER" by pressing CH ▲▼ or Δ∇, then press OK or ▷ to set to "ON".

VHS MODE SET	
→ S-VHS ET	OFF
S-VHS MODE	ON
VIDEO CALIBRATION	ON
PICTURE CONTROL	AUTO
DIGITAL TBC/NR	ON
VIDEO STABILIZER	OFF
NEXT PAGE	
SELECT WITH (▲,▼) AND (OK)	
PRESS (MENU) TO END	



PREVIOUS PAGE	
DIGITAL R3	ON
→ AUTO SP→EP TIMER	ON
SELECT WITH (▲,▼) AND (OK)	
PRESS (MENU) TO END	

4 RETURN TO NORMAL SCREEN

Press MENU.

NOTES:

- If you have programmed the VCR to timer-record 2 or more programs, the second program and those thereafter may not fit on the tape if you set the Auto SP→EP Timer mode to "ON". In this case, make sure the mode is not engaged, then set the tape speed manually during timer programming.
- In order to ensure that the recording fits on the tape, this feature may leave a slight non-recorded section at the end of the tape.
- There may be some noise at the point on the tape where the VCR switches from SP to EP mode.
- The Auto SP→EP Timer feature is not available during ITR (Instant Timer Recording), and the feature will work with the following tapes: T(ST)-30, T(ST)-60, T(ST)-90, and T(ST)-120.

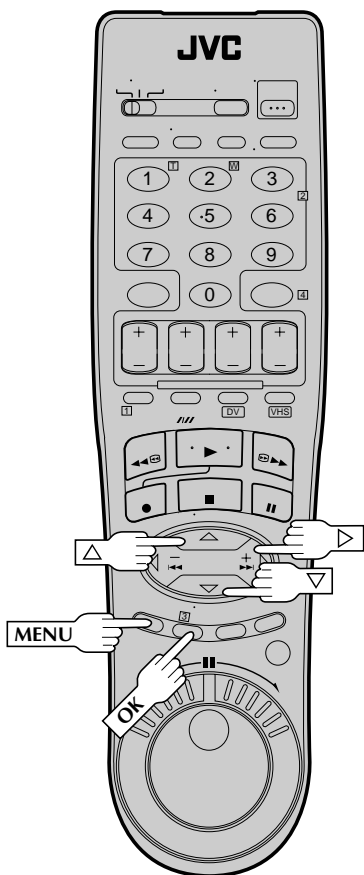
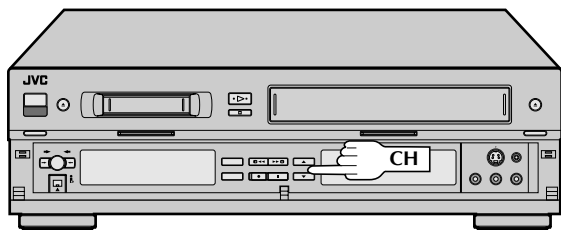

Auto Timer

When the Auto Timer is set to "ON" the timer is automatically engaged when the VCR's power is turned off. It is automatically disengaged when the VCR is powered back on.

1 ACCESS MAIN MENU SCREEN

Press **MENU**.

2 ACCESS MODE SET SCREEN

Move the highlight bar (arrow) to "MODE SET" by pressing **CH▲▼** or **▲▼**, then press **OK** or **▷**.

3 SELECT AUTO TIMER SET MODE

Move the highlight bar (arrow) to "AUTO TIMER" by pressing **CH▲▼** or **▲▼**, then press **OK** or **▷** to set to "ON" or "OFF".

MODE SET	
REAR AUX INPUT	VIDEO
FRONT AUX INPUT	VIDEO
OUTPUT1	AUTO
2ND AUDIO RECORD	OFF
→AUTO TIMER	ON
SUPERIMPOSE	ON

SELECT WITH (▲, ▼) AND (OK)
PRESS (MENU) TO END

4 RETURN TO NORMAL SCREEN

Press **MENU**.

NOTE:

For safety, when "AUTO TIMER" is set to "OFF", all other VCR functions are disabled while the Timer mode is engaged. To disengage the timer, press **TIMER**.

Instant Timer Recording (ITR)

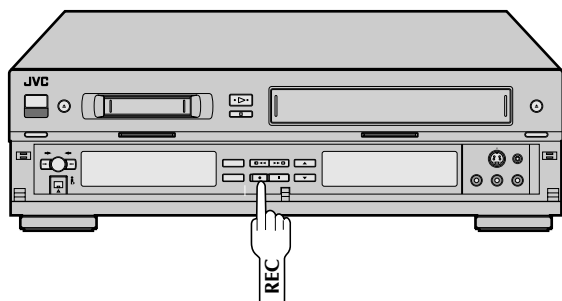

This easy method lets you record from 30 minutes to 6 hours (VHS) or to 120 minutes (DV) (selectable in 30-min. increments) and shuts the VCR off after recording is finished.

START RECORDING

Press **REC** on the front panel.

ENGAGE ITR MODE

Press **REC** again. "⦿" blinks and 0:30 appears on the front display panel.

SET RECORDING DURATION

If you want to record for more than 30 minutes, press **REC** to extend the time. Each press extends recording time by 30 minutes.

NOTES:

- You can only perform ITR using the **REC** button on the VCR's front panel.
- After you set the ITR time, the previous display reappears.
- To check the remaining time, press **REC** once during recording and the remaining time will be displayed for about 5 seconds. Be careful not to press **REC** again within these 5 seconds, or you will round the recording time up to the next 30 minute increment.
- You can play a tape on one deck while using the other deck for Instant Timer Recording. However, remember that the deck will turn itself off when the Instant Timer Recording ends.

Tape Dubbing

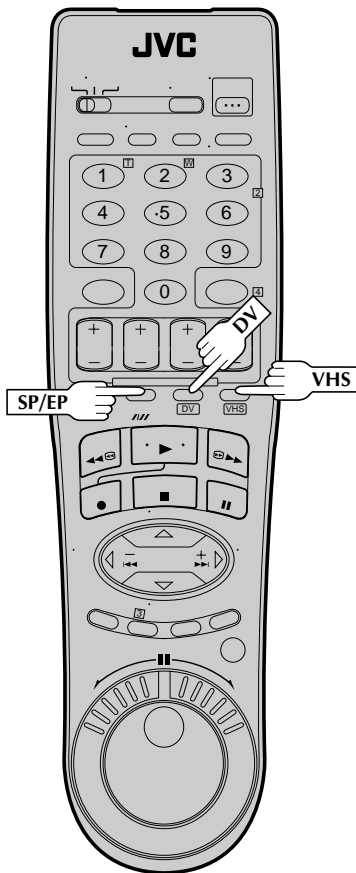
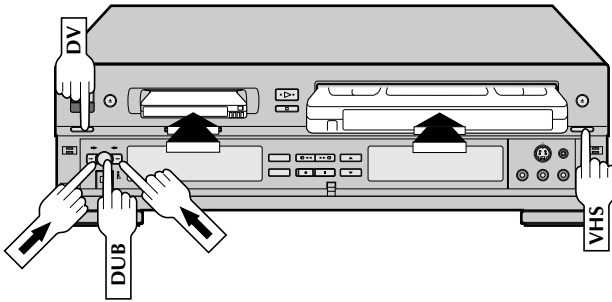

Dubbing An Entire Cassette

Because this VCR includes both a VHS deck and a DV deck, you can easily use it for dubbing without connecting any other equipment.

1 LOAD CASSETTES

Insert a VHS (or S-VHS) cassette and a Mini DV cassette.

2 SELECT DUBBING DIRECTION

Press → when you want playback on the DV deck and recording on the VHS deck.

OR

Press ← when you want playback on the VHS deck and recording on the DV deck.

3 SET TAPE SPEED

Press **VHS** or **DV** for the recording deck, then press **SP/EP** (**SP/LP** for the DV deck).

4 START DUBBING

Press **DUB** for two seconds.

- If the tapes have not been rewound, both decks rewind automatically. The recording deck goes into Record-Pause mode, and the playback deck goes into Pause mode. When both decks have finished rewinding, dubbing begins automatically. After dubbing is completed, the decks rewind both tapes automatically and eject them. The VCR then shuts off.

NOTES:

- If you set the dubbing direction incorrectly, you could erase an important recording that you wanted to copy. We recommend conducting a test with unimportant cassettes first.
- On the cassette that you are playing (i.e., recording from) we recommend either setting the erase protection switch to "SAVE" (if the cassette is a Mini DV cassette), or breaking off the record safety tab (if the cassette is a VHS cassette).

Normal Dubbing

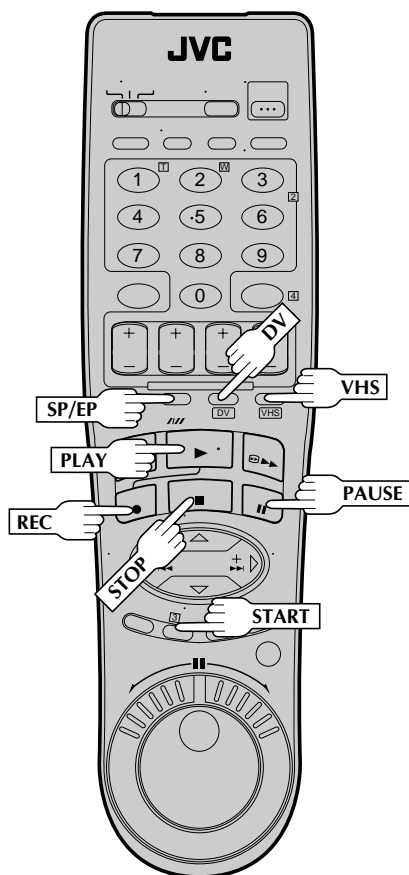
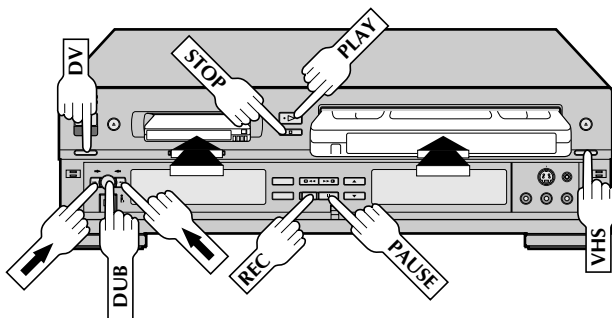

You can dub selected scenes on a tape, starting and stopping wherever you wish.

1 LOAD CASSETTES

Insert a VHS (or S-VHS) cassette and a Mini DV cassette.

2 SELECT DUBBING DIRECTION

Press → when you want playback on the DV deck and recording on the VHS deck.

OR

Press ← when you want playback on the VHS deck and recording on the DV deck.

3 SET TAPE SPEED

Press **VHS** or **DV** for the recording deck, then press **SP/EP** (**SP/LP** for the DV deck).

4 LOCATE START POINT

For the playing deck:

Press **VHS** or **DV** to select the playing deck.

Press **PLAY** to start playback of the tape in the playing deck, and press **PAUSE** to pause playback when you find the point where you want to start dubbing.

For the recording deck:

Press **VHS** or **DV** to select the recording deck. Press and hold **PAUSE** and press **REC** so that the recording deck enters the Record-Pause mode.

5 START DUBBING

Press **START**.

6 PAUSE DUBBING

Press **START**.

7 END DUBBING

Press **STOP**. Then press **VHS** or **DV** to select the playing deck and press **STOP**.

NOTES:

- There may be a discrepancy of several seconds between where you intend editing to start, and where it actually starts.
- The superimposed indication during the operation or dubbing is not recorded.
- When dubbing from the VHS deck to the DV deck, also set "SOUND MODE" to the appropriate mode (☞ pg. 33).

When dubbing from the DV deck to the VHS deck:

- You can record the date and time by setting "DISPLAY" to "ON" (☞ pg. 27).
- You can also insert playback effects (☞ pg. 32).
- When dubbing a Mini DV tape that was produced by audio dubbing, you need to set "32kHz MODE" to the appropriate mode before playing the tape (☞ pg. 33).

Random Assemble Editing

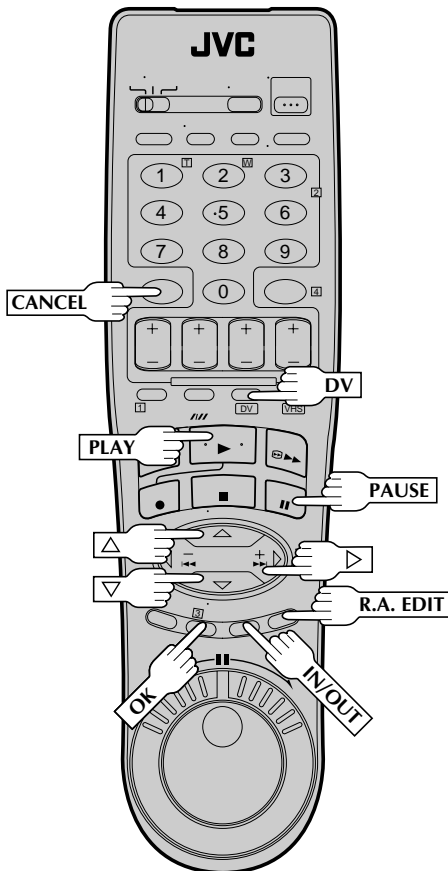
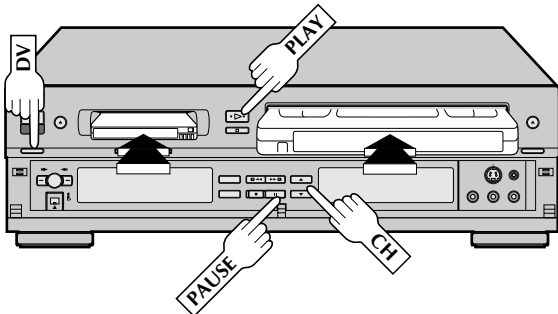

64-program Editing Memory (8 programmes x 8 scenes)

By using the Random Assemble Editing function, you can select up to 8 scenes from a previously recorded Mini DV cassette and automatically dub them onto a VHS cassette. You can also insert Fade/Wipe effects between scenes (see pg. 55), and make changes to the video by using Playback Effects.

Random Assemble Editing is possible only when dubbing from the DV deck to the VHS deck.

1 LOAD CASSETTES

Insert a VHS (or S-VHS) cassette and a Mini DV cassette.

2 SELECT DV DECK

Press **DV**.

3 ACCESS R.A. EDIT SCREEN

Press **R.A. EDIT**. R.A. EDIT screen will appear.

4 SELECT PROGRAMME

Press **CH** ▲▼ or ▲▼ to move the highlight bar (arrow) to the programme number you want to edit, then press **OK** or ▷.

- To remove a programme from the R.A. EDIT screen, select the programme number, then press **CANCEL** for more than 2 seconds.

DV → VHS	
→ P1	--:-- AM --/--/----
P2	--:-- AM --/--/----
P3	--:-- AM --/--/----
P4	--:-- AM --/--/----
P5	--:-- AM --/--/----
P6	--:-- AM --/--/----
P7	--:-- AM --/--/----
P8	--:-- AM --/--/----
[▲▼] → [OK] [R. A. E] : EXIT	

5 LOCATE EDIT-IN POINT

Press **PLAY** to start playback and find the point from where you want the edited scene to begin, then press **PAUSE**. Then press **IN/OUT**. The edit-in point appears on the screen.

P1	IN	OUT	MODE
1	--:--:--:-->		
2		→	
3		→	
4		→	
5		→	
6		→	
7		→	
8		→	
TC	--:--:--	TOTAL	0:00:00

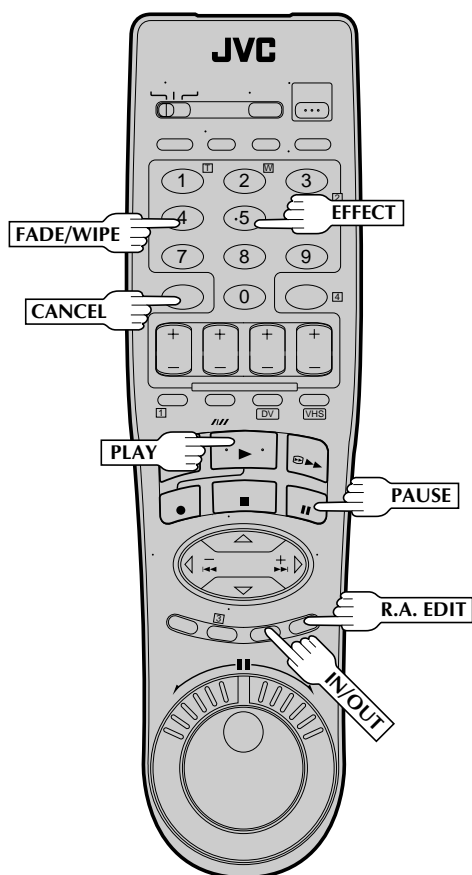

6

LOCATE EDIT-OUT POINT

Press **PLAY** to start playback. Find the point where you want the edited scene to end, then press **PAUSE**.

Then, press **IN/OUT**. The edit-out point appears on the screen.

P1	IN	OUT	MODE
1	-- 0:31:02	→ 0:54:00	----
2	--:--:--	→	
3		→	
4		→	
5		→	
6		→	
7		→	
8		→	
TC 0:00:10		TOTAL	0:22:58

7

USE FADE/WIPE EFFECT ON SCENE TRANSITION (IF NECESSARY)

Press **FADE/WIPE**.

- Cycle through the effects by pressing repeatedly, and stop when the one you want is displayed.
- If you select a Fade/Wipe effect for an Edit-Out point, the effect is automatically applied to the following Edit-In point.
- You can't use a Picture Wipe/Dissolve at the end of the last scene.
- When you use Fade/Wipe effects, that time is included in the total time (this does not apply to Picture Wipe/Dissolve).

P1	IN	OUT	MODE
1	☐ 0:31:02	→ 0:54:00	☐ P --
2	☐ P --:--:--	→	
3		→	
4		→	
5		→	
6		→	
7		→	
8		→	
TC 0:00:10		TOTAL	0:22:58

8

USE PLAYBACK EFFECT (IF NECESSARY)

Press **EFFECT**.

- Cycle through the effects by pressing repeatedly, and stop when the one you want is displayed.
- You can use Classic Film, Monotone, Sepia, Strobe or Video Echo effects. (☐ pg. 32)
- You can also select ☐--:-- so that the date and time are displayed.

P1	IN	OUT	MODE
1	☐ 0:31:02	→ 0:54:00	☐ P ☐
2	☐ P --:--:--	→	
3		→	
4		→	
5		→	
6		→	
7		→	
8		→	
TC 0:00:10		TOTAL	0:22:58

9

REGISTER ADDITIONAL SCENES

Repeat steps 5 – 8.

- To change previously registered points, press **CANCEL**. The registered points disappear, one at a time, from the most recently registered point.
- If you're not using Fade/Wipe or Playback Effects, repeat steps 5 and 6 only.

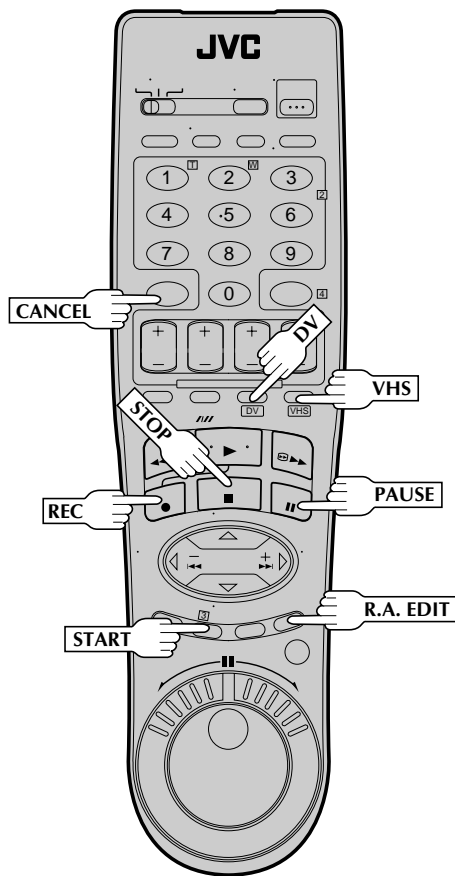

10 PREPARE SOURCE TAPE

Rewind the tape in the DV deck to the beginning of the scene you want to edit.

11 ENGAGE VHS DECK TO RECORD-PAUSE MODE

Press **VHS**, then press and hold **PAUSE** and press **REC** so that the VHS deck enters the Record-Pause mode.

12 START EDITING

Press **START**.

- When dubbing is complete, the DV deck enters the Pause mode, and the VHS deck enters its Record-Pause mode.



















13 STOP EDITING

Press **STOP**. The VHS deck stops recording. Press **DV**, then press **STOP**. The DV deck stops playback.

NOTES:

- When Random Assemble Editing doesn't work, press → of the **DUB** button, then perform Random Assemble Editing again.
- To cancel the registered scene, press **CANCEL**. Each time **CANCEL** is pressed, the latest registered scene is erased.
- When the source tape has more than 2 identical time codes (☞ pg. 27), the recorder may not find the edit-in point you chose and a malfunction may occur.
- When choosing a scene, set edit-in and edit-out points so that there's a relatively large difference between them.
- If the search time for an in-point exceeds 5 minutes, the recording deck's Record-Pause mode will be cancelled and editing will not take place.
- If there are blank portions before or after the edit-in and edit-out points, a blue-backed screen may be included in the edited version.
- Since time codes register time only as accurately as seconds, the time code total time may not match the total programme time exactly.
- To quit Random Assemble Editing while it is still in progress, press **R.A.EDIT** again to return to the R.A.EDIT screen. Press **R.A.EDIT** once more to return to the normal screen.
- To use Random Assemble Editing consecutively for two or more programmes, press **START** for each programme. When dubbing from another Mini DV cassette, swap the Mini DV cassettes first, and then press **START**.
- If you use the Sepia or Monotone Playback Effect, you can't use the Dissolve or Black & White Fader.
- The Classic Film or Strobe Playback Effect does not work, if you use the Picture Wipe or Dissolve.
- The Video Echo Playback Effect does not work, if you use the Fader, Picture Wipe or Dissolve.
- You can't use some of the Fade/Wipe Effects at the beginning or the end of the scene.

FADER AND WIPE MENU

MENU	EFFECT
 FADER — WHITE	Fade in or out with a white screen.
 FADER — BLACK	Fade in or out with a black screen.
 FADER — MOSAIC	Fade in or out with a full-screen mosaic effect.
 FADER — B.W	Fade in to a color screen from a black and white screen, or fade out from color to black and white.
 WIPE — CORNER	Wipe in on a black screen from the upper right to the lower left corner, or wipe out from lower left to upper right, leaving a black screen.
 WIPE — WINDOW	The scene starts in the center of a black screen and wipes in toward the corners, or comes in from the corners, gradually wiping out to the center.
 WIPE — SLIDE	Wipe in from right to left, or wipe out from left to right.
 WIPE — DOOR	Wipe in as the two halves of a black screen open to the left and right, revealing the scene, or wipe out and the black screen reappears from left and right to cover the scene.
 WIPE — SCROLL	The scene wipes in from the bottom to the top of a black screen, or wipes out from top to bottom, leaving a black screen.
 WIPE — SHUTTER	Wipe in toward the center of a black screen from the top and bottom, or wipe out from the center toward the top and bottom, leaving a black screen.
 P DISSOLVE	The new scene gradually appears as the old one gradually disappears.
 P WIPE — CORNER	The new scene wipes in over the previous one from the upper right corner to the lower left corner.
 P WIPE — WINDOW	The next scene gradually wipes in from the center of the screen toward the corners, covering the previous scene.
 P WIPE — SLIDE	The next scene gradually wipes in over the previous one from right to left.
 P WIPE — DOOR	The previous scene wipes out from the center to the right and left, like a door being pushed open to reveal the next scene.
 P WIPE — SCROLL	The new scene wipes in over the last one from the bottom of the screen to the top.
 P WIPE — SHUTTER	The new scene wipes in over the previous one from the center toward the top and bottom of the screen.
	Select when you want to show the date and time on the screen.

Edit From A Camcorder

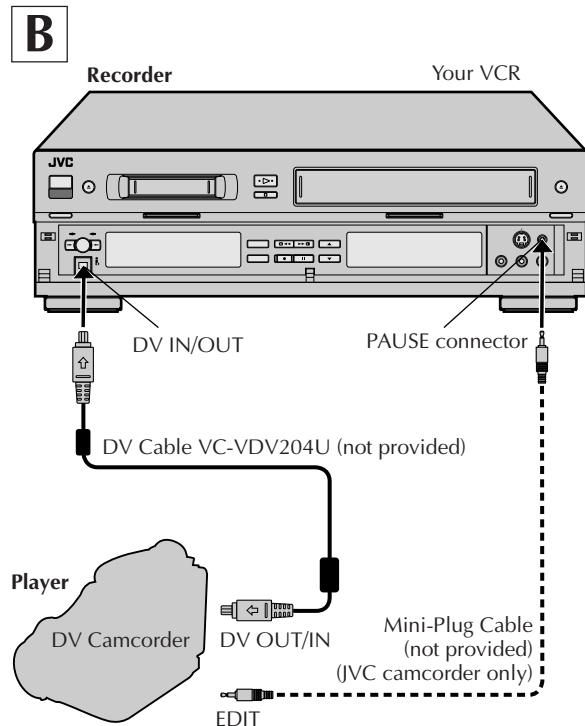
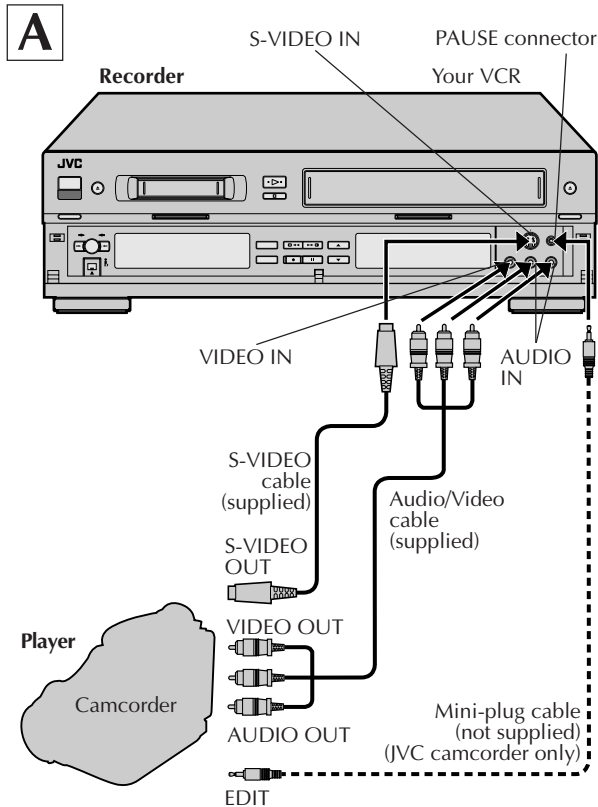

You can use a camcorder as the player and your VCR as the recorder. You can perform digital dubbing if you connect a device such as a camcorder which has a DV output/input connector. Because the signals are digital, there is no loss of video or audio quality as a result of editing.

1 MAKE CONNECTIONS

A *If the camcorder has no DV OUT/IN connector:* Connect an AV cable between the camcorder's VIDEO OUT and AUDIO OUT connectors and your VCR's VIDEO IN and AUDIO IN connectors.

- If connecting a camcorder with an S-VIDEO output connector, it is recommended to use the S-VIDEO connection to minimize picture degradation while editing.
- When a Master Edit Control-equipped JVC camcorder is used, the camcorder is capable of controlling your VCR. The mini-plug cable is a mono 3.5 mm mini-plug to mono 3.5 mm mini-plug connector.
- If connecting to a camcorder with a monaural output, connect the audio output connector on the camcorder to AUDIO IN L of the VCR.

B *If the camcorder has a DV OUT/IN connector:* Connect the camcorder's DV OUT/IN connector to the VCR's DV IN/OUT connector.

2 LOAD A CASSETTE

Insert the cassette to be recorded on into the recorder.

3 SELECT RECORDING DECK

Press VHS or DV.

NOTES:

- When connecting this recorder to a device equipped with a DV input connector, be sure to use the optional DV cable (VC-VDV204U).
- The signals through the DV IN/OUT connector cannot be recorded on the VHS deck, even though → of the **DUB** button is pressed.
- When you are editing through the DV IN/OUT connector, the recorder will stop if the player begins playing a blank portion of tape or the signal is interrupted.

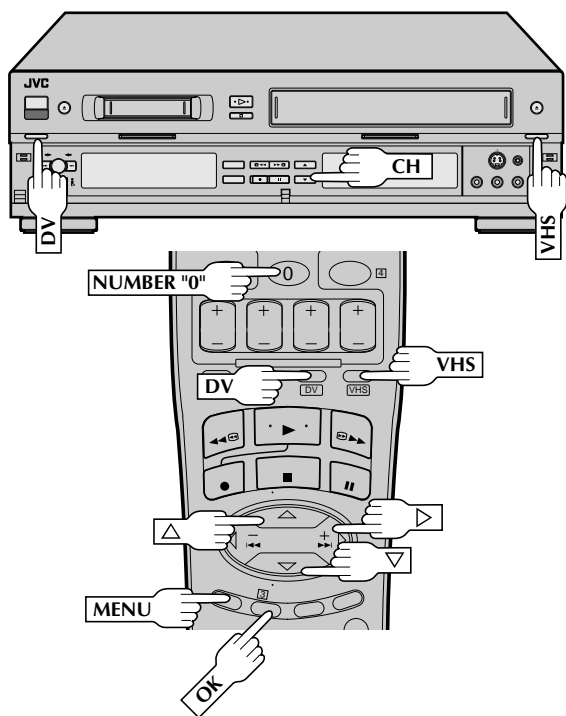

4

SET RECORDER'S INPUT MODE

Set to "AUX". Press the **NUMBER** key "0" and/or **CH** to select depending on the connector being used – "L-1" for the rear panel input connectors, or "L-2" for the front panel input connectors.

5

ACCESS MAIN MENU SCREEN

Press **MENU**.

6

ACCESS MODE SET SCREEN

Press **CH** ▲▼ or ▲▽ to move the highlight bar (arrow) to "MODE SET", then press **OK** or ▷.

7

SELECT AUX INPUT SET MODE

a- FRONT S-VIDEO IN :

Move the highlight bar (arrow) to "FRONT AUX INPUT" by pressing **CH** ▲▼ or ▲▽, then press **OK** or ▷ to set to "S-VIDEO".

b- FRONT VIDEO IN:

Move the highlight bar (arrow) to "FRONT AUX INPUT" by pressing **CH** ▲▼ or ▲▽, then press **OK** or ▷ to set to "VIDEO".

c- REAR S-VIDEO IN:

Move the highlight bar (arrow) to "REAR AUX INPUT" by pressing **CH** ▲▼ or ▲▽, then press **OK** or ▷ to set to "S-VIDEO".

d- REAR VIDEO IN: Move the highlight bar (arrow) to "REAR AUX INPUT" by pressing **CH** ▲▼ or ▲▽, then press **OK** or ▷ to set to "VIDEO".

MODE SET	
REAR AUX INPUT	VIDEO
→ FRONT AUX INPUT	VIDEO
OUTPUT1	AUTO
2ND AUDIO RECORD	OFF
AUTO TIMER	OFF
SUPERIMPOSE	ON

SELECT WITH (▲,▼) AND (OK)
PRESS (MENU) TO END

MODE SET	
→ REAR AUX INPUT	VIDEO
FRONT AUX INPUT	VIDEO
OUTPUT1	AUTO
2ND AUDIO RECORD	OFF
AUTO TIMER	OFF
SUPERIMPOSE	ON

SELECT WITH (▲,▼) AND (OK)
PRESS (MENU) TO END

8

SELECT "EDIT" FOR PICTURE CONTROL SET MODE (VHS DECK ONLY)

Follow the "Picture Control" section on page 28, then select "EDIT."

NOTE:

When you select "EDIT" to dub tapes, be sure to select "AUTO" or ("NORM" when "VIDEO CALIBRATION" is set to "OFF") after you finish dubbing the tapes.

9

RETURN TO NORMAL SCREEN

Press **MENU**.

10

START PLAYER

Set the camcorder to its play mode.

NOTE:

If the camcorder is equipped with a superimpose/OSD disable feature then set its superimpose or display feature to OFF before pressing play.

11

START RECORDER

Set your VCR to its record mode.

- If you are using a Master Edit Control-equipped JVC camcorder, it can put the recorder automatically into Record mode. (Refer to camcorder's instruction manual.)

NOTE:

If you use an auxiliary input to connect a cable box or DBS receiver, make sure that the correct AUX INPUT ("VIDEO" or "S-VIDEO") is selected after you have finished editing (steps 5 – 7).

Edit To Or From Another VCR

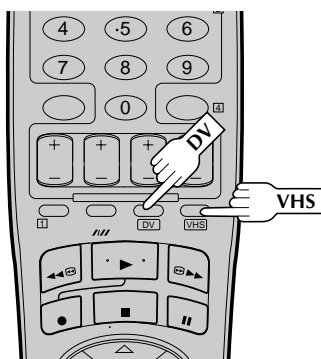
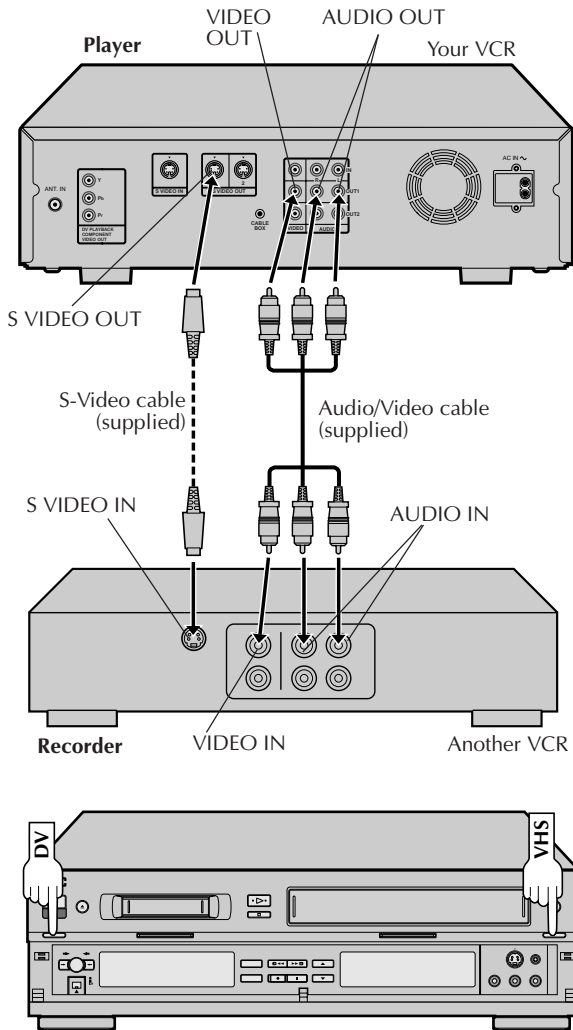

You can use your VCR as the player or the recorder.

1 MAKE CONNECTIONS

Connect an AV cable between the player's VIDEO OUT and AUDIO OUT connectors and the recorder's VIDEO IN and AUDIO IN connectors.

- If using another VCR with an S-VIDEO input or output connector, it is recommended to use the S-VIDEO connection to minimize picture degradation while editing.
- When using your VCR as the recorder and a monaural VCR as the player, connect the player's AUDIO OUT connector to the AUDIO IN L connector on the recorder.

2 LOAD CASSETTES

Insert the playback cassette into the player and the cassette to be recorded on into the recorder.

3 SELECT DECK

Press **VHS** or **DV**.

- When using your VCR as the source player, set "OUTPUT1" to "VHS" or "DV", depending on the deck being selected (☞ pg. 59).

Advantages Of S-VHS Editing

S-VHS allows you make high resolution video recordings when dubbing from one VCR to another.

You can edit from VHS to S-VHS, from S-VHS to VHS, or from S-VHS to S-VHS.

- From VHS to S-VHS: Record VHS playback signals in the S-VHS mode. Although the picture quality is inherently limited by the original VHS source material, the edited tape has better picture quality than those made by VHS-to-VHS editing.
- From S-VHS to VHS: Because the picture quality of the source material is very high, the edited tape has better picture quality than those made by VHS-to-VHS editing.
- From S-VHS to S-VHS: A high resolution copy is made of a high resolution original S-VHS tape with minimal picture degradation. This is the preferred method of video dubbing.

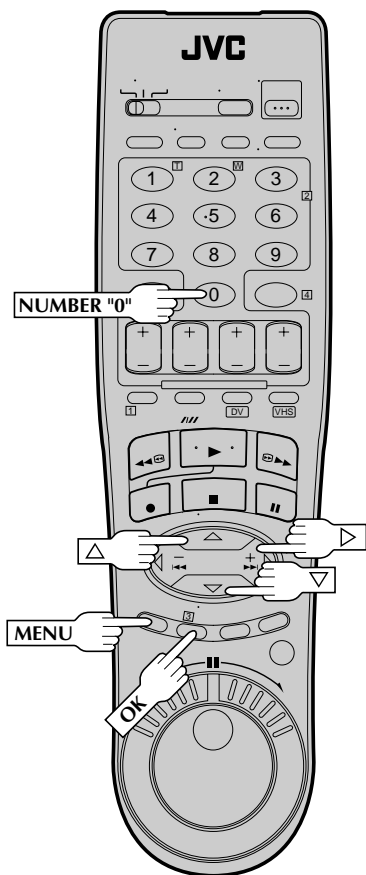
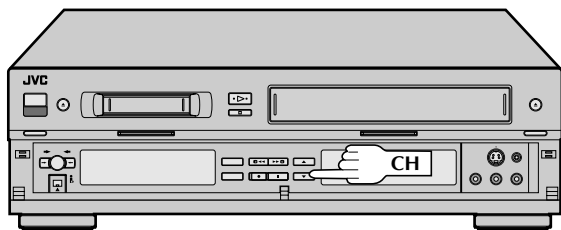

4 SET RECORDER'S INPUT MODE

Set to "AUX". With this VCR, press the **NUMBER** key "0" and/or **CH** to select depending on the connector being used – "L-1" for the rear AUDIO/VIDEO IN connector, or "L-2" for the front AUDIO/VIDEO IN connector.

NOTE:

If you use your VCR as the recorder and have connected another VCR to your VCR's S-VIDEO IN connector, you need to set "REAR AUX INPUT" to "S-VIDEO" at the Mode Set screen. Follow steps 5 – 7 from the "Edit From A Camcorder" section (☞ pg. 57).

5 SELECT "EDIT" FOR PICTURE CONTROL SET MODE (VHS DECK ONLY)

Follow the "Picture Control" section on page 28, then select "EDIT."

NOTE:

When you select "EDIT" to dub tapes, be sure to select "AUTO" or ("NORM" when "VIDEO CALIBRATION" is set to "OFF") after you finish dubbing the tapes.

6 START PLAYER

Set to its play mode.

NOTE:

If the player is equipped with a superimpose/OSD disable feature then set "SUPERIMPOSE" to "OFF" before pressing **PLAY** (☞ pg. 25).

7 START RECORDER

Set to its record mode.

NOTE:

If you use an auxiliary input to connect a cable box or DBS receiver, make sure that the correct AUX INPUT ("VIDEO" or "S-VIDEO") is selected after you have finished editing (☞ steps 5 – 7, page 57).

OUTPUT1 Setting

Set "OUTPUT1" to the appropriate mode depending on the selection of the playing deck (VHS or DV) for editing.

- 1 Press **MENU** to access the Main Menu screen.
- 2 Press **CH** ▲▼ or ▲▽ to move the highlight bar (arrow) to "MODE SET", then press **OK** or ▷.
- 3 Press **CH** ▲▼ or ▲▽ to move the highlight bar (arrow) to "OUTPUT1".
- 4 Press **OK** or ▷ to select "AUTO", "VHS" or "DV".
 - a-AUTO : The VCR outputs the signals from the deck being used automatically. The superimposed indication is also output.
 - b-VHS : The VCR outputs only the signals from the VHS deck. The superimposed indication is not output.
 - c-DV : The VCR outputs only the signals from the DV deck. The superimposed indication is not output.
- 5 Press **MENU** to return to normal screen.

MODE SET	
REAR AUX INPUT	VIDEO
FRONT AUX INPUT	VIDEO
→ OUTPUT1	AUTO
2ND AUDIO RECORD	OFF
AUTO TIMER	OFF
SUPERIMPOSE	ON

SELECT WITH (▲, ▼) AND (OK)
PRESS (MENU) TO END

Audio Dubbing

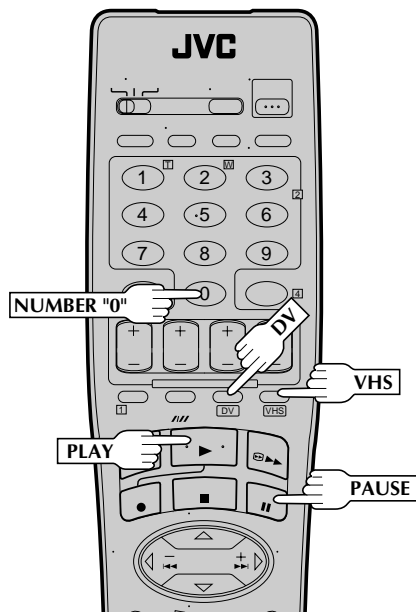
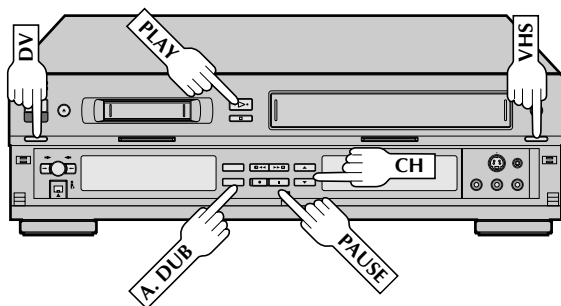
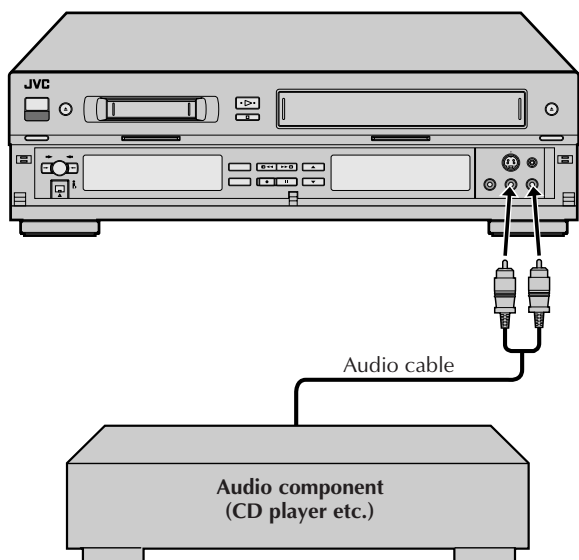

VHS Audio Dubbing

Audio dubbing replaces the normal audio sound of a previously recorded tape with a new soundtrack. Use your VCR as the recorder.

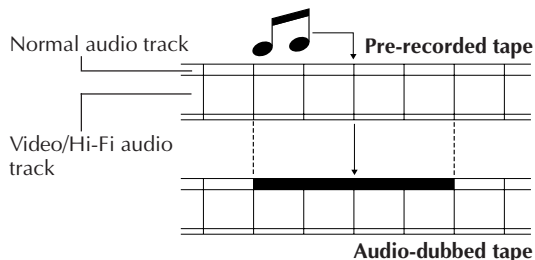

DV Audio Dubbing

This function lets you record new audio, without erasing the original audio, on a DV tape that was recorded with "SOUND MODE" set to "32kHz" (see pg. 33). You can then play back audio that you recorded by connecting other audio or video equipment to this VCR.

You cannot perform audio dubbing on a tape that was recorded with "SOUND MODE" set to "48kHz", on a tape that was recorded at the "LP" speed, or on a blank tape.

MAKE CONNECTIONS

1 Connect an audio component to the AUDIO IN L + R connectors on the VCR's front panel. *When connecting monaural equipment, use only the VCR's AUDIO IN L connector.

SELECT RECORDING DECK

2 Press **VHS** or **DV**.

- When using the DV deck as the recording deck, press ← so that the audio signals from the AUDIO L + R input connectors can be recorded.

SET INPUT MODE

3 Press the remote control's **NUMBER** key "0" and **CH** so that "L-2" appears in place of a channel number.

LOCATE START POINT

4 Press **PLAY** to start playback of the tape in your VCR, and press **PAUSE** when you find the point where you want to start dubbing.

ENGAGE AUDIO DUBBING

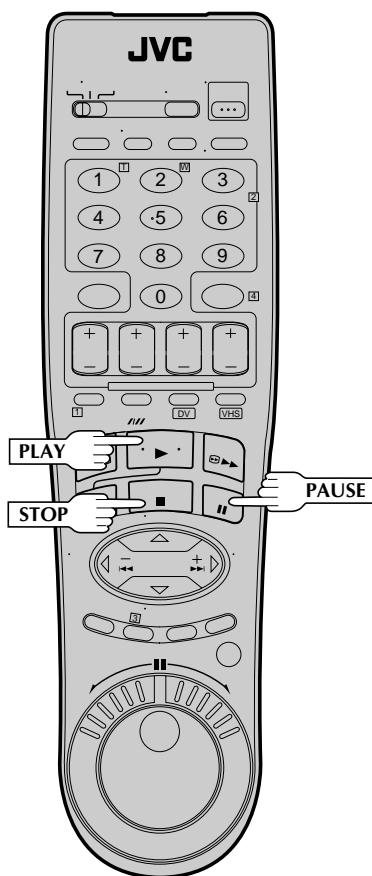
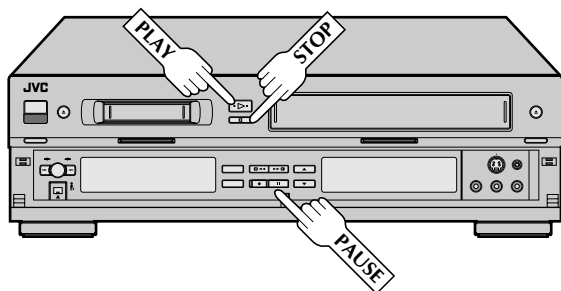

5 Press **A. DUB**.

- Your VCR enters the Audio Dubbing Pause mode. (○ blinks, ▶ and ■ light up on the front display panel.)



6 START DUBBING

Engage the audio component's Play mode, then press **PLAY** to start the tape in your VCR. Audio dubbing begins at this point.

-  blinks and  is displayed on the front display panel.
- To stop dubbing temporarily, press **PAUSE**. Press **PLAY** to resume dubbing.

7 END AUDIO DUBBING

Press **STOP** to stop the tape in your VCR, and engage the audio component's Stop mode.

NOTES:

- When monitoring the sound during Audio Dubbing, the normal soundtrack is automatically selected. If you wish to hear the Hi-Fi or mixed sound (Hi-Fi + Normal soundtracks), refer to the "Select The Soundtrack" section (pg. 29) and select the soundtrack you wish to hear. (VHS deck only)
- Audio dubbing stops automatically when the counter reaches "0:00:00", and the VCR enters the Play mode. Check the counter reading before dubbing. (VHS deck only)
- Audio dubbing is also possible using the rear AUDIO IN connectors.
- Audio dubbing cannot be performed on a VHS/S-VHS cassette that has had its record safety tab removed, or on a Mini DV cassette that has had its erase protection switch set to "SAVE".
- When playing back an audio-dubbed tape, refer to the "Select The Soundtrack" section (pg. 29) to select the soundtrack you wish to hear.
- Picture may be distorted during Audio Dubbing Pause.
- It may be unlawful to record or play back copyrighted material without the consent of the copyright owner.
- Audio dubbing is not possible using the DV IN/OUT connector.

Insert Editing

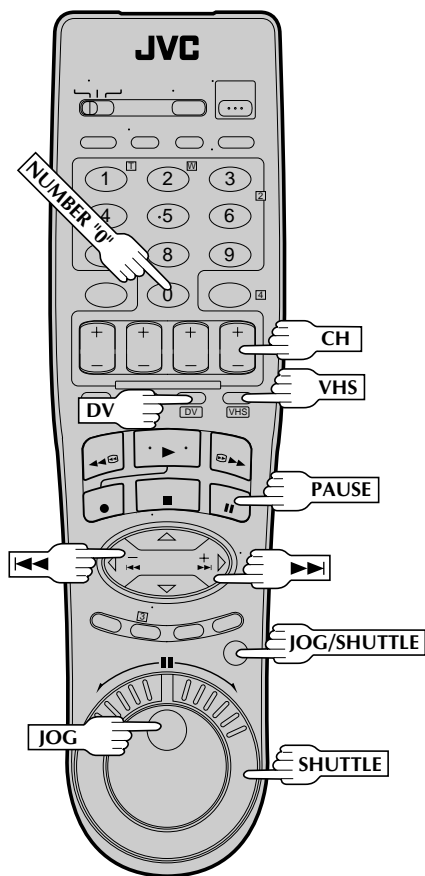
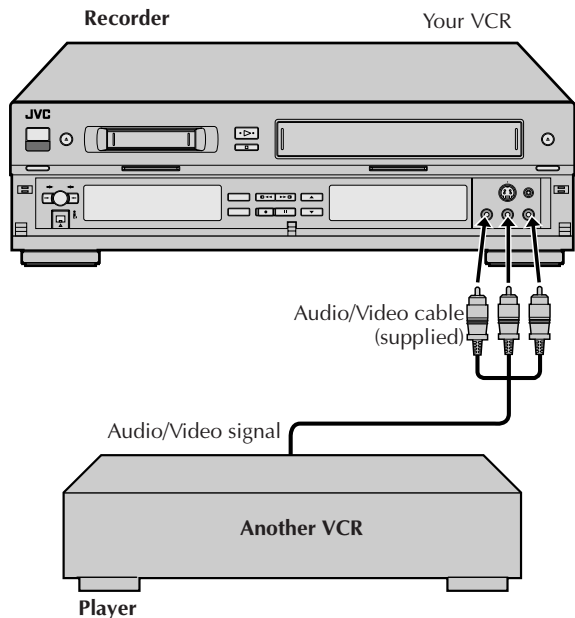

VHS Insert Editing

Insert editing replaces part of the recorded scene with new material. Both the picture and Hi-Fi audio soundtrack are replaced with new ones, while the normal audio soundtrack remains unchanged. If you wish to change the normal audio track as well, use the audio dubbing function simultaneously. Use your VCR as the recorder.

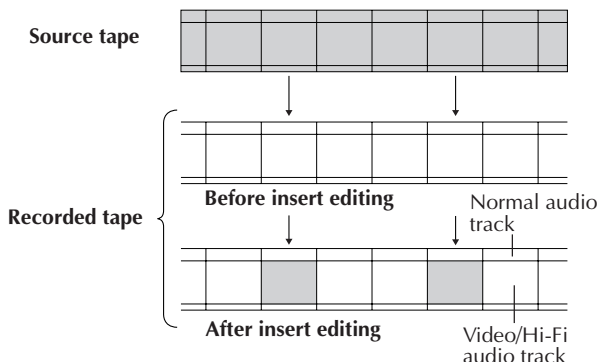

DV Insert Editing (SP Mode Only)

The picture is replaced with new one, while the audio soundtrack remains unchanged. Use your VCR as the recorder.

1 MAKE CONNECTIONS

Connect the player's VIDEO OUT or S-VIDEO OUT and AUDIO OUT connectors to your VCR's VIDEO IN or S-VIDEO IN and AUDIO IN on the front panel.

2 SELECT RECORDING DECK

Press **VHS** or **DV**.

- When using the DV deck as the recording deck, press **←** so that the video and audio signals from the VIDEO/S-VIDEO and AUDIO L + R input connectors can be recorded.

3 SET INPUT MODE

Press the **NUMBER** key "0" and **CH** so that "L-2" appears in place of a channel number.

- Be sure to select the correct FRONT AUX INPUT ("VIDEO" or "S-VIDEO"). (To select the correct AUX INPUT, follow steps 5 - 7 from the "Edit From A Camcorder" section [pg. 57](#).)

4 LOCATE END POINT (VHS DECK ONLY)

Load the recording cassette into your VCR, and play it back to determine the edit-out point (the end of the segment to be replaced) using the **JOG/SHUTTLE** controls or pressing **◀◀▶▶** and **PAUSE**.

- To use the **JOG** dial/**SHUTTLE** ring, first press the **JOG/SHUTTLE** button on the remote control so that the button lights up.

NOTE:

Insert Editing is not possible with a Mini DV tape recorded in LP mode.

Connecting To A Video Titler

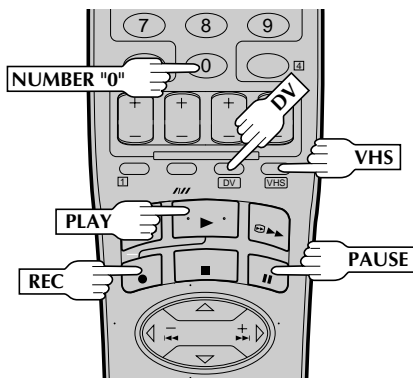
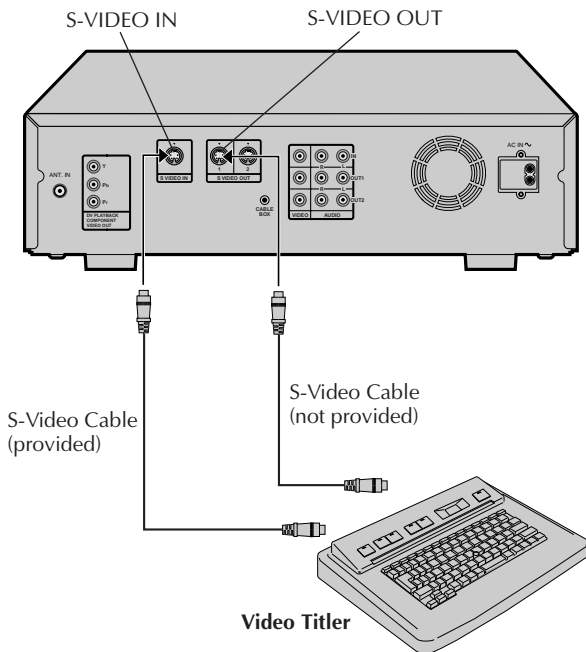

NOTES:

- For the operation of the video titler, refer to its instruction manual.
- If the playing deck is left in the Pause mode, it will automatically go into Stop mode for the protection of the video tape and the video head. The duration of the Pause mode is 3 minutes for the DV deck and 5 minutes for the VHS deck.
- If the recording deck is left in the Record-Pause mode, it will automatically go into Stop mode for the protection of the video tape and the video head. The duration of the Record-Pause mode is 3 minutes for the DV deck and 5 minutes for the VHS deck.

When you edit from the DV deck to the VHS deck (or from the VHS deck to the DV deck), you can enter a title to a scene by connecting a video titler.

1 MAKE CONNECTIONS

Connect the VCR and the video titler as shown in the illustration on the left column.

2 PREPARE PLAYING DECK

Insert a cassette for playback and make the title you want to display.

- When using the DV deck as the source player, set "OUTPUT1" to "DV" (☞ pg. 59).
- When using the VHS deck as the source player, set "OUTPUT1" to "VHS" (☞ pg. 59).
- For details of making a title, refer to the instruction manual for the video titler.

3 PREPARE RECORDING DECK

Insert a cassette for recording and press **DV** or **VHS** for the recording deck.
To set recording deck's input mode, press **NUMBER** key "0" and/or **CH** to select "L-1".

- Set "REAR AUX INPUT" to "S-VIDEO" (☞ pg. 57).

4 LOCATE START POINT

Press **DV** or **VHS** for the playing deck.
Press **PLAY** to start playback and find the beginning of the scene you want to edit, then press **PAUSE**.

5 PREPARE VIDEO TITLER

Prepare the video titler so that the title can be displayed.

6 ENGAGE RECORD-PAUSE MODE

Press **DV** or **VHS** for the recording deck, then press and hold **PAUSE** and press **REC** so that the recording deck enters its Record-Pause mode.

7 START PLAYBACK

Press **DV** or **VHS** for the playing deck, then press **PLAY**.

8 START RECORDING

Press **DV** or **VHS** for the recording deck, then press **REC** at the point from where you want to start recording.

9 ENTER TITLE

Enter a title at the point where you want the title to be displayed.

Connecting To A Printer

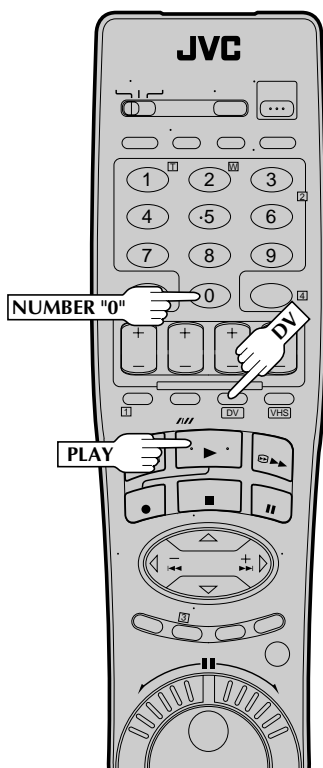
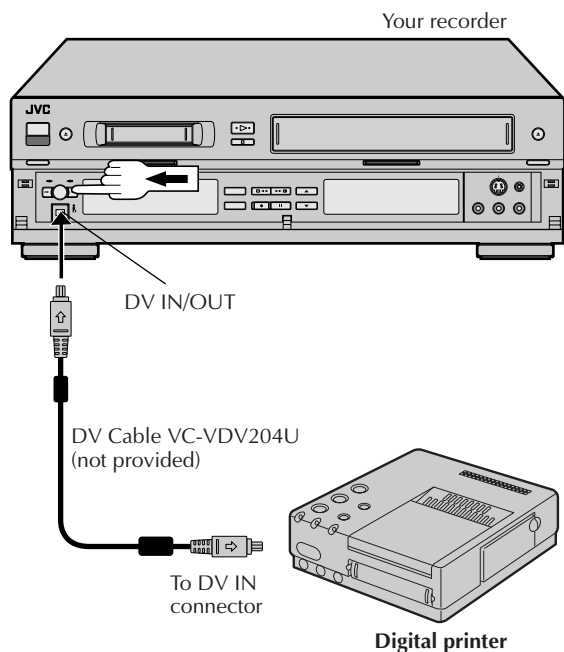

You can make printouts of video images by connecting the GV-DT1/GV-DT3 Digital Printer (sold separately) to the DV IN/OUT connector.

1 MAKE CONNECTIONS

Connect the printer's DV IN connector to the recorder's DV IN/OUT connector.

2 SELECT DECK

Press **DV**.

- When you use the VHS deck . . .
 . . . after pressing **DV**, press **NUMBER** key "0" and/or **CH** to select "L-2". Then, press ← of the **DUB** button.

3 START PLAYBACK

Press **PLAY**.

- **DV**
 The image being displayed on the TV screen is output to the digital printer. Any on-screen displays are not output. Playback Effects are not output, either.
- **VHS**
 The image being played back by the VHS deck is output to the digital printer. Any on-screen displays are not output.

NOTE:

When connecting this recorder to a device equipped with a DV input connector, be sure to use the optional DV cable (VC-VDV204U).

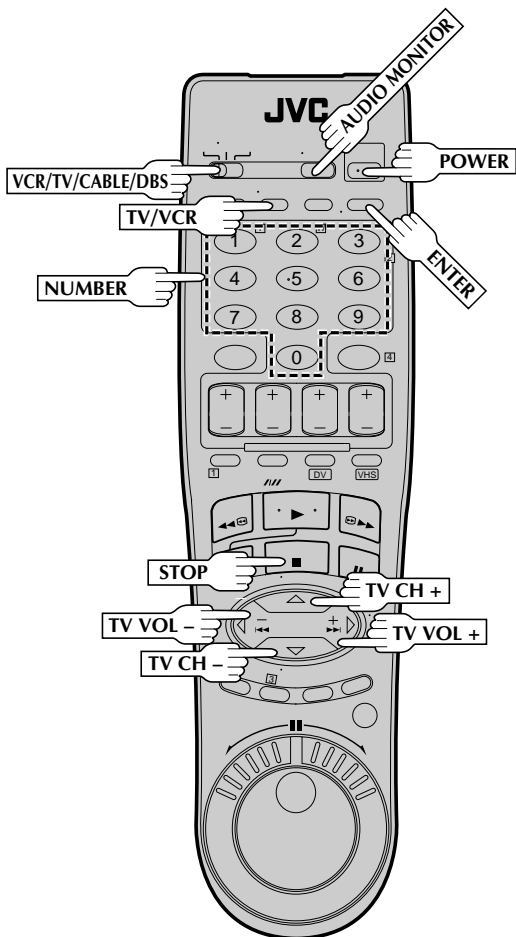

TV Multi-Brand Remote Control

The VCR's remote control can control several functions on JVC remote control TVs and on the brands of remote control TVs listed below.

1 TURN ON THE TV

Turn the power on using the TV's remote control.

2 SET REMOTE CONTROL MODE

Set the **VCR/TV/CABLE/DBS** switch on the VCR's remote control to TV.

3 SET TV BRAND CODE

Refer to the chart below. While holding down **POWER** on the VCR's remote control, enter your TV's brand code using the **NUMBER** keys, then press **STOP**. Follow the example shown at bottom left.

- Once you have set the remote control to operate the TV, you don't have to repeat this step until you replace your remote control's batteries.
- PANASONIC has two codes. If the TV does not function with one code, try entering the other.

4 OPERATE TV

First, press **POWER** on the remote to see if the TV's power goes off as it should. If it does, try other operations.

- The **POWER**, **TV/VCR**, **TV CH +/-**, **TV VOL +/-**, **AUDIO MONITOR** (TV Muting) and **NUMBER** keys on the remote can all be used to operate the TV. *For some brands of TV, you must press **ENTER** after having pressed the **NUMBER** keys.
- To return the remote to VCR control, set the **VCR/TV/CABLE/DBS** switch to VCR.

NOTE:

Depending on the type of TV, there may be cases where some or all functions cannot be operated using the remote control.

TV BRAND NAME	BRAND CODE
JVC	01
MAGNAVOX	02
MITSUBISHI	03
PANASONIC	04, 11
RCA	05
SHARP	06
SONY	07
TOSHIBA	08
ZENITH	09
HITACHI	10
SAMSUNG	12
SANYO	13
SEARS	13

(Ex.) To set remote control to RCA 05:

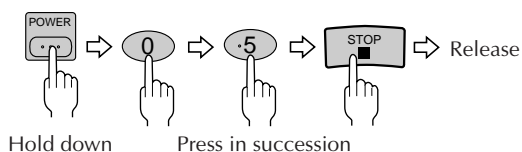

Cable Box Multi-Brand Remote Control

The VCR's remote control can control functions on the brands of cable boxes listed below. Some cable box brands have more than one code. If your cable box does not function with a specified code, try other codes.

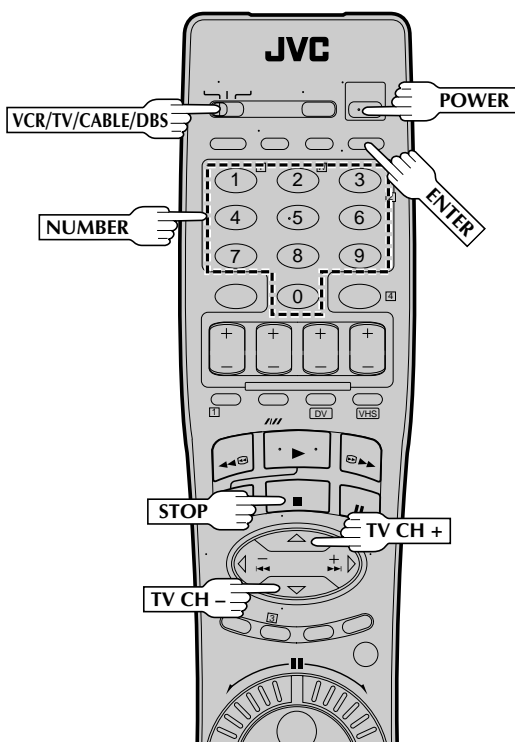

1 TURN ON THE CABLE BOX

Turn the power on using the cable box's remote control.

2 SET REMOTE CONTROL MODE

Set the **VCR/TV/CABLE/DBS** switch on the VCR's remote control to **CABLE/DBS**.

3 ENTER CABLE BOX BRAND

While holding down **POWER** on the VCR's remote control, use the **NUMBER** keys to enter the cable box brand number from the chart at bottom left and then press **STOP**. Follow the example shown below.

- Once you have set the remote control to operate the cable box, you don't have to repeat this step until you replace the remote control's batteries.

4 OPERATE CABLE BOX

First, press **POWER** to see if the cable box's power goes off as it should. If it does, try other functions (**TV CH +/-** and the **NUMBER** keys can be used to operate the cable box).

- For some brands of cable box, you must press **ENTER** after having pressed the **NUMBER** keys.
- To return the remote to VCR control, set the **VCR/TV/CABLE/DBS** switch to **VCR**.

NOTES:

- You must set the cable box brand for your remote control and the cable box brand for your Controller (pg. 16) separately. The list of cable box brands that can be controlled by your remote control is different from the list of brands that can be controlled by your controller.
- Depending on the type of cable box, there may be cases where some or all functions cannot be operated using the remote control.
- It's not possible to set the remote control for both your cable box and a DBS receiver at the same time. You can only set the remote control to operate one of these units at a time.

(Ex.) To set remote control to RCA 14:

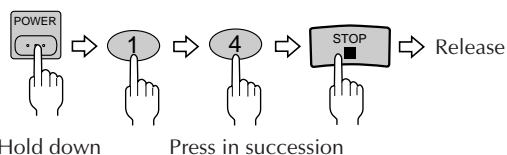

CABLE BOX BRAND NAME	BRAND CODE
ARCHER	01, 05, 17
CABLETENNA	01, 17
CABLEVIEW	15, 16, 17, 21, 25
CITIZEN	15, 16, 17, 21, 25
CURTIS	02, 08
DIAMOND	01, 17
EASTERN	19
GC BRAND	15, 16, 17, 21, 25
GEMINI	15
GENERAL INSTRUMENTS	01, 04, 06, 11, 12, 15
HAMLIN	10, 18, 19, 23
JASCO	15
JERROLD	01, 04, 06, 11, 12, 15
NOVAVISION	02, 08
OAK	07, 20
PANASONIC	13, 14
PULSER	15, 16, 17, 21, 25
RCA	13, 14
REGAL	10, 18, 19, 23
REGENCY	19
REMBRANDT	01, 16, 17
SAMSUNG	05, 16, 24
SCIENTIFIC ATLANTA	02, 08
SIGMA	07, 20
SL MARX	05, 16, 17, 24, 25
SPRUCER	13, 14
STARGATE	05, 15, 16, 17, 21, 24, 25
TELEVIEW	05, 16, 24
TOCOM	01, 04, 16
UNIKA	01, 17
UNIVERSAL	16, 17, 25
VIDEOWAY	03, 09, 22
ZENITH	03, 09, 22

DBS Receiver Multi-Brand Remote Control

The VCR's remote control can control functions on the brands of DBS (Direct Broadcast Satellite) receivers listed below.

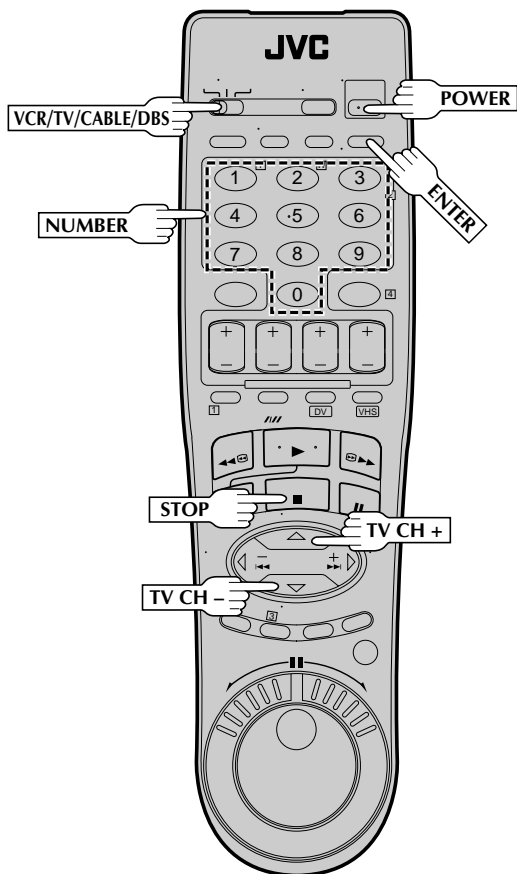

1 TURN ON THE DBS RECEIVER

Turn the power on using the DBS receiver's remote control.

2 SET REMOTE CONTROL MODE

Set the **VCR/TV/CABLE/DBS** switch on the VCR's remote control to **CABLE/DBS**.

3 ENTER DBS RECEIVER BRAND

While holding down **POWER** on the VCR's remote control, use the **NUMBER** keys to enter the DBS receiver brand number from the chart below and then press **STOP**. Follow the example shown at bottom left.

- Once you have set the remote control to operate the DBS receiver, you don't have to repeat this step until you replace the remote control's batteries.

4 OPERATE DBS RECEIVER

First, press **POWER** to see if the DBS receiver's power goes off as it should. If it does, try other functions (**TV CH +/-** and the **NUMBER** keys can be used to operate the DBS receiver).

- For some brands of DBS receiver, you must press **ENTER** after having pressed the **NUMBER** keys.
- To return the remote to VCR control, set the **VCR/TV/CABLE/DBS** switch to VCR.

NOTES:

- You must set the DBS receiver brand for your remote control and the DBS receiver brand for your Controller (pg. 19) separately.
- Depending on the type of DBS receiver, there may be cases where some or all functions cannot be operated using the remote control.
- It's not possible to operate a DBS receiver that is not equipped with a remote control sensor.
- Though ECHOSTAR has a number of different remote codes, this remote control is applicable only to one of those codes preset at the factory.
- It's not possible to set the remote control for both your DBS receiver and a cable box at the same time. You can only set the remote control to operate one of these units at a time.

DBS BRAND NAME	BRAND CODE
JVC (DISH Network)	51
ECHOSTAR (DISH Network)	51
PRIMESTAR	50
SONY (DSS)	41
RCA (DSS)	40

(Ex.) To set remote control to JVC 51:

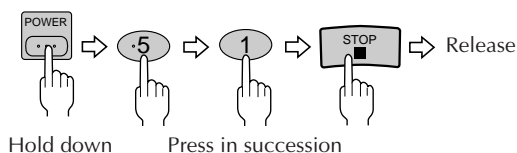

Control Two JVC VCRs

The remote control is capable of controlling two JVC VCRs independently; one set to respond to your remote control's **A** code control signals and another set to respond to **B** code control signals. The remote control is preset to send **A** code signals because your VCR is initially set to respond to **A** code signals. You can easily modify your VCR to respond to **B** code signals.

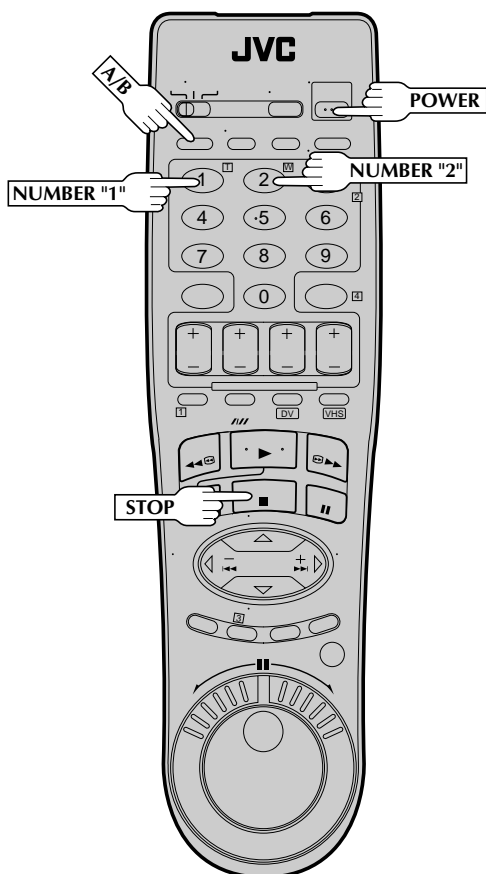

1 UNPLUG VCR'S POWER CORD

Unplug from the AC outlet.

2 SET REMOTE CONTROL CODE

While holding down **A/B** on the remote control, press the **NUMBER** key "2" and then press **STOP**.

3 PLUG IN POWER CORD

Plug back in to the AC outlet.

4 TURN VCR POWER ON

Press **POWER** on the remote.

The VCR will now respond only to **B**-code commands. To set the VCR back to respond to **A** code signals, repeat the same procedure as shown above except pressing **NUMBER** key "1" instead of "2" in step 2.

You can control two VCRs with the same remote control by switching the remote's code between **A** and **B** (⇐ Step 2), pressing "1" for **A**-code commands and "2" for **B**-code commands.

(Ex.) To set remote control **B** code:

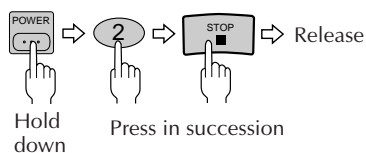

Before requesting service for a problem, use this chart and see if you can repair the trouble yourself. Small problems are often easily corrected, and this can save you the trouble of sending your VCR off for repair.

POWER

SYMPTOM	POSSIBLE CAUSE	CORRECTIVE ACTION
1. The power won't come on.	<ul style="list-style-type: none"> The power cord is disconnected. 	Connect the power cord.
2. The clock works, but the VCR's power won't come on.	<ul style="list-style-type: none"> The TIMER mode is engaged with "Auto Timer" set to "OFF" (☞ pg. 48). 	Press TIMER to disengage.
3. The remote control won't function.	<ul style="list-style-type: none"> The batteries are discharged. 	Replace the dead batteries with new ones.

TAPE TRANSPORT

SYMPTOM	POSSIBLE CAUSE	CORRECTIVE ACTION
1. The cassette gets stuck partway during loading, and is ejected.	<ul style="list-style-type: none"> The cassette was inserted incorrectly. 	Make sure the cassette's window is facing up, the rear label side is facing you and the arrow on the front of the cassette is pointing towards the VCR. Then insert the cassette.

PLAYBACK

SYMPTOM	POSSIBLE CAUSE	CORRECTIVE ACTION
1. The tape is running but the picture won't appear.	<ul style="list-style-type: none"> The TV receiver is set to the wrong mode. 	Set the TV receiver to its AV mode.
2. Noise appears during visual search.	<ul style="list-style-type: none"> This is normal. 	
3. Breaks are noticeable in Hi-Fi soundtrack.	<ul style="list-style-type: none"> Automatic tracking is engaged. 	Disengage Auto Tracking and adjust the tracking manually (☞ pg. 26).
4. The playback picture is blurred or interrupted, even though TV broadcasts are clear.	<ul style="list-style-type: none"> The video heads may be dirty. 	The heads must be cleaned. Consult your JVC dealer.
5. The Hi-Fi soundtrack cannot be heard.	<ul style="list-style-type: none"> The soundtrack option was set incorrectly. 	Press A. MONITOR to select "HI-FI" (☞ pg. 29).

RECORDING

SYMPTOM	POSSIBLE CAUSE	CORRECTIVE ACTION
1. Recording won't start.	<ul style="list-style-type: none"> VHS deck There is no cassette loaded, or the cassette loaded has had its Record Safety tab removed. DV deck There is no cassette loaded, or the cassette loaded has had its erase protection switch set to "SAVE". 	<p>Insert a cassette, or using adhesive tape, reseal the slot where the tab was removed.</p> <p>Insert a cassette, or set the erase protection switch to "REC".</p>
2. TV broadcasts won't record properly.	<ul style="list-style-type: none"> The VCR has been set to its AUX mode by mistake. 	Set the VCR to the appropriate channel.
3. Tape-to-tape editing won't work.	<ul style="list-style-type: none"> The VCRs or the camcorder and the VCR have been incorrectly connected. The power to one or more of the units has not been turned on. The recorder's input mode has been set incorrectly. 	<p>Refer to the directions and the illustration under "Edit To Or From Another VCR" (☞ pg. 58) or "Edit From A Camcorder" (☞ pg. 56) and properly connect the units. Make sure the power to all units is on.</p> <p>Select the recorder's appropriate input mode.</p>

RECORDING

SYMPTOM	POSSIBLE CAUSE	CORRECTIVE ACTION
4. Audio dubbing is not possible.	<ul style="list-style-type: none"> ● "SOUND MODE" on the DV Mode Set Menu had been set to "48kHz" at the original recording. ● The tape speed had been set to LP at the original recording. 	<p>Set "SOUND MODE" to "32kHz" at the original recording (☞ pg. 33).</p> <p>Set the tape speed to SP at the original recording.</p>
5. Monitoring the audio-dubbed sound is not possible during audio dubbing using the DV deck.	<ul style="list-style-type: none"> ● This is normal. 	<p>Monitor the sound using the connected devices.</p>
6. The programmed memory of Random Assemble Editing is disappeared.	<ul style="list-style-type: none"> ● The memory backup time has expired. 	<p>Perform Random Assemble Editing again.</p>
7. When performing Tape Dubbing, the beginning of the dubbing start point is not dubbed.	<ul style="list-style-type: none"> ● This is normal. 	

TIMER RECORDING

SYMPTOM	POSSIBLE CAUSE	CORRECTIVE ACTION
1. Timer recording won't work.	<ul style="list-style-type: none"> ● The clock and/or the timer have been set incorrectly. ● The timer is not engaged. ● The VCR has not been set up properly. 	<p>Set the clock and/or timer correctly.</p> <p>Press TIMER and check to make sure that ☉ appears on the front display panel.</p> <p>Re-perform the set-up procedures. Make sure you have compensated for Guide Channel and VCR or cable box channel number mismatches (☞ pg. 42).</p>
2. Timer programming won't work.	<ul style="list-style-type: none"> ● Timer recording is in progress. 	<p>Timer programming can't be performed when timer recording is in progress. Wait until it finishes.</p>
3. ☉ and ☐ on the front display panel won't stop blinking.	<ul style="list-style-type: none"> ● The timer is engaged but there's no cassette loaded. 	<p>VHS deck Load a cassette with the Record Safety tab intact, or cover the hole using adhesive tape.</p> <p>DV deck Load a cassette with the erase protection switch set to "REC".</p>
4. The cassette is automatically ejected, and ☉ and ☐ on the front display panel won't stop blinking.	<ul style="list-style-type: none"> ● VHS deck The loaded cassette has had its Record Safety tab removed. ● DV deck The loaded cassette has had its erase protection switch set to "SAVE". 	<p>Remove the cassette and cover the hole with adhesive tape, or insert a cassette with the Record Safety tab intact.</p> <p>Remove the cassette and set the erase protection switch to "REC".</p>
5. ☉ blinks for 10 seconds and the timer mode is disengaged.	<ul style="list-style-type: none"> ● TIMER has been pressed when there are no programs in memory, or the timer record program information has not been programmed correctly. 	<p>Check the programmed data and re-program as necessary, then press TIMER again.</p>
6. The cassette is automatically ejected, the power shuts off and ☉ and ☐ won't stop blinking.	<ul style="list-style-type: none"> ● The end of tape was reached during timer recording. 	<p>The program may not have been recorded in its entirety. Next time make sure you have enough time on the tape to record the entire program.</p>

CONTINUED ON NEXT PAGE

TIMER RECORDING

SYMPTOM	POSSIBLE CAUSE	CORRECTIVE ACTION
7. Cable channels are not automatically switched during timer recording.	<ul style="list-style-type: none"> ● The Controller is not properly connected to the VCR. ● The output channel selected in the Cable Box Set screen is incorrect. ● The cable box's power is off. 	Connect the Controller correctly (☞ pg. 15). After confirming your cable box's output channel number, re-access the Cable Box Set screen and select the correct number (☞ pg. 16). Make sure the power is on before timer recording starts.
8. Satellite channels are not automatically switched during timer recording.	<ul style="list-style-type: none"> ● The Controller is not properly connected to the VCR. ● The output channel selected in the DBS Receiver Set screen is incorrect. ● The VCR is not set correctly to control the DBS Receiver. ● The DBS receiver's power is off. 	Connect the Controller correctly (☞ pg. 18). After confirming your DBS receiver's output channel number, re-access the DBS Receiver Set screen and select the correct number (☞ pg. 19). Set the correct DBS Receiver brand code (☞ pg. 20). Make sure the power is on before timer recording starts.
9. Timer recording begins as scheduled, but the channel is always incorrect.	<ul style="list-style-type: none"> ● Even though you don't use an external Cable Box, "CABLE BOX SET" is set to "ON". 	Set "CABLE BOX SET" to "OFF" (☞ pg. 16).
10. We moved, and now the VCR Plus+ system doesn't work properly.	<ul style="list-style-type: none"> ● The receivable stations in the new area are received on different channels than those in the previous area. 	Re-perform the VCR Plus+ setup procedure (☞ pg. 42).
11. "PROGRAM FULL" is displayed on the screen.	<ul style="list-style-type: none"> ● All 6 programs on the VHS or DV deck's timer memory are used. 	Wait until a space in memory clears, or cancel unnecessary program information (☞ pg. 46).

OTHER PROBLEMS

SYMPTOM	POSSIBLE CAUSE	CORRECTIVE ACTION
1. When scanning channels, some of them are skipped over.	<ul style="list-style-type: none"> ● Those channels have been preset to be skipped. 	If you need the skipped channels, restore them (☞ pg. 14).
2. The channel can't be changed.	<ul style="list-style-type: none"> ● Recording is in progress. 	Press PAUSE to pause the recording, change channels, then press PLAY to resume recording.
3. The remote control won't operate my TV or cable box or DBS receiver.	<ul style="list-style-type: none"> ● The remote control brand setting is incorrect. 	Re-set the remote control to the correct brand (☞ pg. 66 or 67 or 68).
4. Even though Auto or Semi-Auto clock setting has been selected, the clock is incorrect.	<ul style="list-style-type: none"> ● The clock setting data received from the Host Channel is incorrect. 	Select a different Host Channel during the Semi-Auto setting procedure (☞ pg. 11), or perform the Manual setting procedure (☞ pg. 12).

ATTENTION

This VCR contains microcomputers. External electronic noise or interference can cause microcomputer to malfunction. If the VCR does not operate correctly switch its power off and unplug the power cord from the AC supply. Wait for a while and then plug the power back in. Eject and check the condition of the cassette. If everything appears normal resume operating the VCR as usual.

PLAYBACK

Q. What happens if the end of the tape is reached during playback or search?

A. The tape is automatically rewound to the beginning.

Q. Can the VCR indefinitely remain in the still mode?

A. No. It stops automatically after 5 minutes (VHS deck) or 3 minutes (DV deck) to protect the heads.

Q. During search, still and frame-by-frame playback, the picture is intermittent. What's the cause?

A. Picture loss occurs when these types of playback are attempted with a tape recorded in LP mode. Pressing PLAY to return to normal playback will restore the picture.

Q. When returning from multi-speed search to normal playback, the picture is disturbed. Should I be concerned about this?

A. No, it is normal.

Q. When playing back programs that have been timer-recorded with consecutive times (such one program from 8:00 to 9:00 and another one from 9:00 to 10:00), the picture and sound become momentarily distorted at the point where the first program ends and the second program begins. Is this a malfunction?

A. No. This is normal.

Q. Other than preventing further recording, what effect does removing the safety tab have?

A. It disables marking of index codes.

Q. Sometimes, during Index Search, the VCR can't find the program I want to see. Why not?

A. There may be index codes too close together.

Q. During playback, on-screen operational indicators sometimes jitter. Why does this happen?

A. If the condition of the tape being played back is not good, jittering of the video (including on-screen indicators) may occur.

RECORDING

Q. When I pause and then resume a recording, the end of the recording before the pause is overlapped by the new recording. Why does this happen?

A. This is normal. It reduces distortion at the pause and resume points.

Q. Can the VCR indefinitely remain in the Record-Pause mode?

A. No. The VCR automatically goes to its Stop mode after 5 minutes (VHS deck) or 3 minutes (DV deck) to protect the heads. When paused during Instant Timer Recording (ITR), the VCR shuts off automatically after 5 minutes (VHS deck) or 3 minutes (DV deck).

Q. What happens if the tape runs out during recording?

A. The VCR automatically rewinds it to the beginning.

TIMER RECORDING

Q. REC and ⊕ remain lit on the front display panel. Is there a problem?

A. No. This is a normal condition for a timer recording in progress.

Q. Can I program the timer while I'm watching a tape or a TV broadcast?

A. Yes, but while you are setting the timer you won't see the tape's or broadcast program's picture as it is replaced by the on-screen menu. The audio from the tape or broadcast program will be present during the setting of the timer.

FRONT VIEW

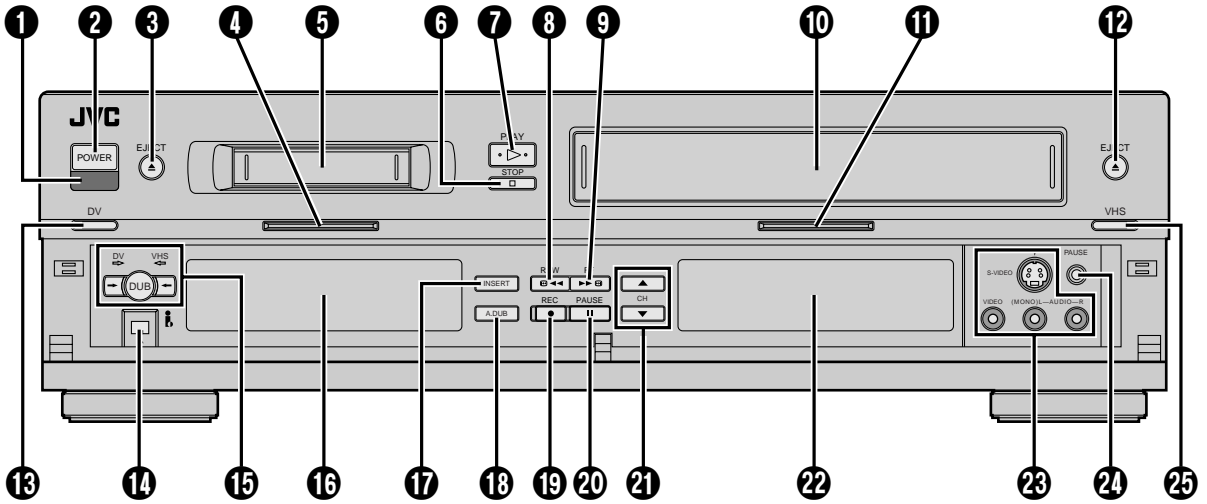

- ❶ Remote Control Sensor
- ❷ Power On/Off Button (☞ pg. 9)
- ❸ DV EJECT Button (☞ pg. 21)
- ❹ DV Indicator (☞ pg. 21)
- ❺ Mini DV Cassette Loading Slot
- ❻ STOP Button (☞ pg. 21)
- ❼ PLAY Button (☞ pg. 21)
- ❽ Rewind [REW] Button (☞ pg. 21)
- ❾ Fast Forward [FF] Button (☞ pg. 21)
- ❿ VHS Cassette Loading Slot
- ⓫ VHS Indicator (☞ pg. 21)
- ⓬ VHS EJECT Button (☞ pg. 21)
- ⓭ DV Button (☞ pg. 21)
- ⓮ DV IN/OUT connector (i.Link*) (☞ pg. 56)
- ⓯ Dubbing [DUB] Button (☞ pg. 50)
- ⓰ Dubbing Direction [→/←] Buttons (☞ pg. 50)
- ⓱ DV Display Panel (☞ pg. 76)
- ⓲ INSERT Button (☞ pg. 62)
- ⓳ Audio Dubbing [A. DUB] Button (☞ pg. 60)
- ⓴ Record [REC] Button (☞ pg. 22)
- ⓵ PAUSE Button (☞ pg. 23)
- ⓶ Channel [CH] ▲▼ Button (☞ pg. 22)
- ⓷ VHS Display Panel (☞ pg. 76)
- ⓸ S-VIDEO/VIDEO/AUDIO Input Connectors (☞ pg. 56)
- ⓹ Remote PAUSE connector (☞ pg. 56)
- ⓺ VHS Button (☞ pg. 21)

*i.Link refers to the IEEE1394-1995 industry specification and extensions thereof. The  logo is used for products compliant with the i.Link standard.

REAR VIEW

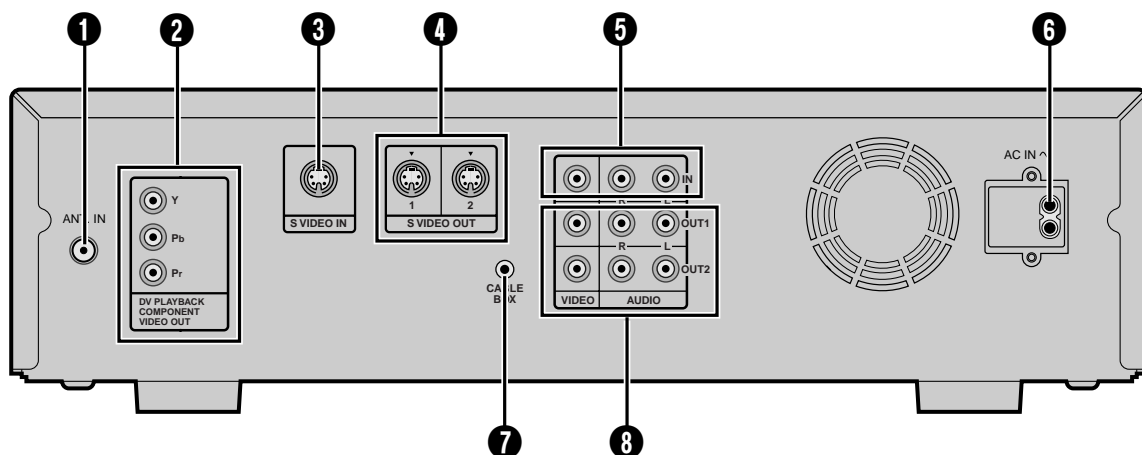

- ❶ ANT. IN Connector (☞ pg. 6)
- ❷ DV PLAYBACK COMPONENT VIDEO Output Connectors (☞ pg. 7)
- ❸ S VIDEO Input Connector (☞ pg. 64)
- ❹ S VIDEO Output Connectors (☞ pg. 7)

- ❺ VIDEO/AUDIO Input Connectors
- ❻ AC Power Inlet (☞ pg. 6)
- ❼ CABLE BOX Controller Connector (☞ pg. 15, 18)
- ❽ VIDEO/AUDIO Output Connectors (☞ pg. 58)

VHS DISPLAY PANEL

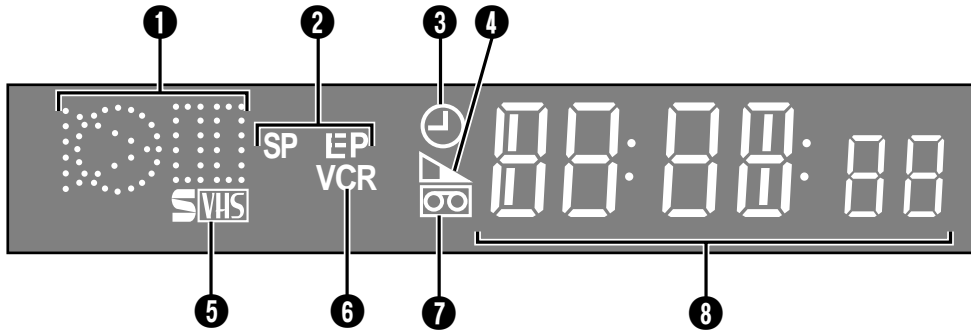

- ❶ Symbolic Mode Indicators (Refer to the chart below)
- ❷ Tape Speed Indicators (☞ pg. 22)
- ❸ Timer Mode Indicator (☞ pg. 41, 45)
- ❹ Tape Remaining Time Indicator (☞ pg. 36)
- ❺ S-VHS Indicator (☞ pg. 38)
- ❻ VCR Mode Indicator
- ❼ "Cassette Loaded" Mark
- ❽ Channel Display ["L-1" and "L-2" for AUX mode] Counter Display (☞ pg. 8) Clock Display (☞ pg. 8)

DV DISPLAY PANEL

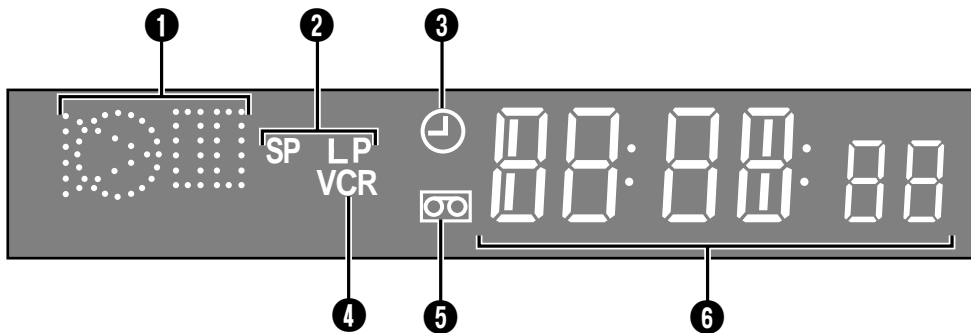

- ❶ Symbolic Mode Indicators
- ❷ Tape Speed Indicators (☞ pg. 22)
- ❸ Timer Mode Indicator (☞ pg. 41, 45)
- ❹ VCR Mode Indicator
- ❺ "Cassette Loaded" Mark
- ❻ Channel Display ["L-1" and "L-2" for AUX mode] Time Code Display (☞ pg. 27) Clock Display (☞ pg. 8)

PLAY: FF/REW VARIABLE SEARCH:	▶	STILL: SLOW:	▶
		RECORD:	○
		RECORD PAUSE:	○
AUDIO DUBBING:			☀
AUDIO DUBBING PAUSE:			☀
INSERT:			Ⓜ
INSERT PAUSE:			Ⓜ
AUDIO DUBBING INSERT:			☀
AUDIO DUBBING INSERT PAUSE:			☀

REMOTE CONTROL

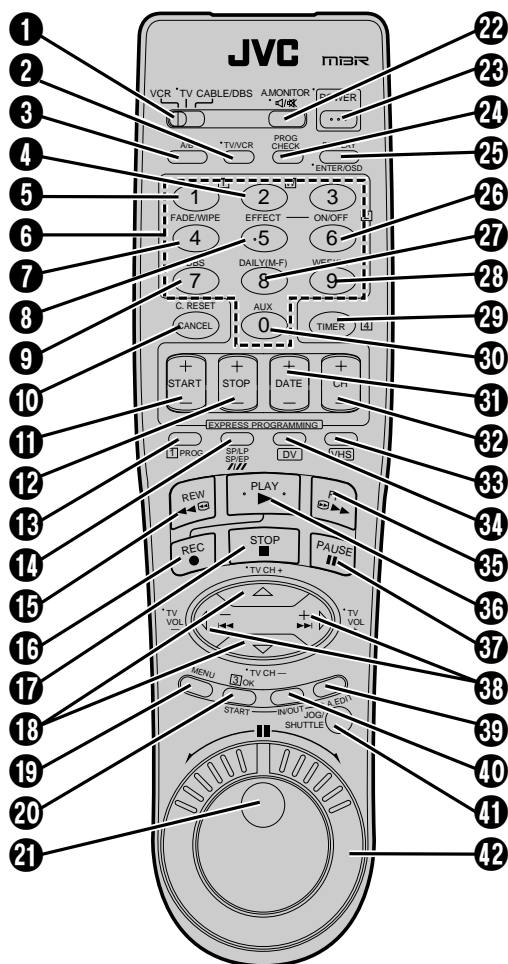

Buttons with a small dot on the left side of the name can also be used to operate your TV with the **VCR/TV/CABLE/DBS** switch set to TV. [pg. 66](#)

How To Use

The remote control can operate most of your VCR's functions, as well as basic functions of TV sets, Cable Boxes and DBS Receivers.

- Point the remote control toward the sensor window.
- The maximum operating distance of the remote control is about 8 m.

NOTES:

- When inserting the batteries, be sure to insert in the correct directions as indicated under the battery cover.
- If the remote control doesn't work properly, remove its batteries. Replace with fully charged batteries and then try again.

- 1 VCR/TV/CABLE/DBS Switch ([pg. 66, 67, 68](#))
- 2 TV/VCR Button ([pg. 66](#))
- 3 A/B Code Button ([pg. 69](#))
- 4 Zoom Button [W] ([pg. 32](#))
- 5 Zoom Button [T] ([pg. 32](#))
- 6 NUMBER Buttons ([pg. 22, 40, 66, 67, 68](#))
- 7 FADE/WIPE Button ([pg. 53](#))
- 8 EFFECT Button ([pg. 32, 53](#))
- 9 DBS Button ([pg. 45](#))
- 10 CANCEL Button ([pg. 46](#))
- 11 Counter [C.] RESET Button ([pg. 27](#))
- 12 START +/- Button ([pg. 44](#))
- 13 STOP +/- Button ([pg. 44](#))
- 14 PROG. Button ([pg. 40, 44](#))
- 15 Recording Speed [SP/LP, SP/EP] Button ([pg. 22](#))
- 16 Rewind [REW] Button ([pg. 21](#))
- 17 Record [REC] Button ([pg. 22](#))
- 18 STOP Button ([pg. 21](#))
- 19 $\Delta \nabla$ Button ([pg. 9](#))
- 20 TV Channel [CH] +/- ([pg. 66, 67, 68](#))
- 21 MENU Button ([pg. 9](#))
- 22 OK Button ([pg. 9](#))
- 23 START Button ([pg. 51, 54](#))
- 24 JOG Dial ([pg. 23](#))
- 25 Audio [A.] MONITOR Button ([pg. 29, 33](#))
- 26 TV Muting Button ([pg. 66](#))
- 27 Power On/Off Button ([pg. 9](#))
- 28 PROG. CHECK Button ([pg. 46](#))
- 29 DISPLAY Button ([pg. 27](#))
- 30 ENTER Button ([pg. 22](#))
- 31 On-Screen Display [OSD] Button ([pg. 25](#))
- 32 ON/OFF Button ([pg. 32](#))
- 33 DAILY Timer Recording Button ([pg. 41, 45](#))
- 34 WEEKLY Timer Recording Button ([pg. 41, 45](#))
- 35 TIMER Button ([pg. 41, 45](#))
- 36 "AUX" Mode Select Button ([pg. 56](#))
- 37 DATE +/- Button ([pg. 44](#))
- 38 Channel [CH] +/- Button ([pg. 22, 44](#))
- 39 VHS Button ([pg. 21](#))
- 40 DV Button ([pg. 21](#))
- 41 Fast Forward [FF] Button ([pg. 21](#))
- 42 PLAY Button ([pg. 21](#))
- 43 PAUSE Button ([pg. 23](#))
- 44 $\ll \gg$ ($\triangleleft \triangleright$) Button ([pg. 23, 27](#))
- 45 TV Volume [VOL] +/- Button ([pg. 66](#))
- 46 R.A. EDIT Button ([pg. 52](#))
- 47 IN/OUT Button ([pg. 52](#))
- 48 JOG/SHUTTLE Button ([pg. 23](#))
- 49 SHUTTLE Ring ([pg. 23](#))

List Of Terms

This guide serves as a quick way to locate frequently used terms and on-screen display names.

A

A/B Code	69
Active Video Calibration	34
Add Channel	14
Audio Dubbing	60
Audio Monitor	29
Auto Channel Setting	13
Auto Daylight Saving Time	11
Auto SP→EP Timer	47
Auto Timer	48
Automatic Tracking	26
Aux Input	56

B

Band	13
------------	----

C

Cable Box	15
Cable Box Brand Setting	17
Cable Box Controller	15
Cancel Program	46
Cassette Adapter	21
Changing VCR Plus+® Setting	42
Check Program	46
Component Video Connection	7
Connection to Printer	65
Connection to TV	6
Connection to Video Titler	64
Contents	5
Counter Reset	27

D

DBS Receiver	18
DBS Receiver Brand Setting	20
DBS Receiver Controller	18
Delete Channel	14
Digital R ³	31
Digital TBC/NR	30
Display Mode Setting	27

E

Editing	50
Express Timer Programming	44

F

Frame-by-Frame Playback	23
-------------------------------	----

G

Guide Channel Setting	43
-----------------------------	----

H

Host Channel Selection	11
------------------------------	----

I

Index Search	26
Insert Cassette	21
Insert Editing	62
ITR (Instant Timer Recording)	49

J

JOG Dial	24
----------------	----

L

Language Selection	9
--------------------------	---

M

Main Menu	9
Manual Channel Setting	14
Manual Clock Setting	12
Manual Tracking	26
MBR (Multi-Brand Remote) Code Setting	66

N

Next-Function Memory	27
Normal Dubbing	51

O

On-Screen Display	25
-------------------------	----

P

PBS Channel	8
Playback	21
Playback Effect	32
Plug & Play	8

R

Random Assemble Editing	52
Record Safety Tab	37
Recording	22
Repeat Playback	27
Retake	37
Reverse Motion Playback	23
Reverse Slow Motion Playback	23

S

SAP (Second Audio Program)	37
Second Audio	37
Select Cable Box Output Channel	16
Select DBS Receiver Output Channel	19
Semi-Auto Clock Setting	11
SHUTTLE ring	24
Slow Motion Playback	23
Sound Mode Selection	33
Specifications	79
Still Picture Playback	23
Superimpose	25
S-VHS (Super VHS)	38
S-VHS ET	39
S-Video Connection	7

T

Tape Dubbing	50
Tape Position Indicator	27
Tape Speed Setting	22
Time Code	27
Time Zone Selection	12
Tuner Setting	13

V

Variable-Speed Search	24
VCR Plus+® Timer Programming	40
Video Stabilizer	29

Z

Zoom	32
------------	----

32kHz Mode Setting	33
--------------------------	----

GENERAL

Power requirement	: AC 120 V~, 60 Hz
Power consumption	
Power on	: 42 W
Power off	: 5.5 W
Temperature	
Operating	: 5°C to 40°C (41°F to 104°F)
Storage	: -20°C to 60°C (-4°F to 140°F)
Operating position	: Horizontal only
Dimensions (WxHxD)	: 437 mm x 127 mm x 390 mm (17-1/4" x 5" x 15-3/8")
Weight	: 7.5 kg (16.5 lbs)
Input/Output	: RCA connectors: (IN x 2, OUT x 2) S-Video connectors: (IN x 2, OUT x 2) DV connectors: (IN/OUT x 1) (4-pin, IEEE1394 conformity, digital input/output) DV playback component video connector: (OUT x 1)

VHS DECK VIDEO/AUDIO

Signal system	: NTSC-type colour signal and EIA monochrome signal, 525 lines/ 60 fields
Recording system	: DA4 (Double Azimuth) head helical scan system
Format	: S-VHS/VHS NTSC standard
Signal-to-noise ratio	: 45 dB
Horizontal resolution	: 240 lines (VHS) 400 lines (S-VHS)
Frequency range	: 70 Hz to 10,000 Hz (Normal audio) 20 Hz to 20,000 Hz (Hi-Fi audio)
Maximum recording time	
(SP)	: 210 min. with ST-210 video cassette
(EP)	: 630 min. with ST-210 video cassette

DV DECK VIDEO/AUDIO

Signal system	: NTSC-type colour signal, 525 lines/60 fields
Recording system	: Digital Component Recording
Format	: DV format (SD mode)
Cassette	: Mini DV Cassette
Maximum recording time	
(SP)	: 60 min. with M-DV60ME cassette
(LP)	: 90 min. with M-DV60ME cassette
Audio recording system	: PCM 48 kHz, 16 bit (2 ch)/ 32 kHz, 12 bit (4 ch)

TUNER

Tuning system	: Frequency-synthesized tuner
Channel coverage	
VHF	: Channels 2-13
UHF	: Channels 14-69
CATV	: 113 Channels

TIMER

Clock reference	: Quartz
Program capacity	: 1-year programmable timer/ 6 programs each on the VHS and DV deck
Memory backup time	: Approx. 60 min.

ACCESSORIES

Provided accessories	: RF cable (F-type), Infrared remote control unit, "AA" battery x 2, Audio/Video Cable, S-Video cable (4-pin), Power cord, Antenna splitter, Controller
----------------------	--

*Specifications shown are for SP mode unless otherwise specified.
E. & O.E. Design and specifications subject to change without
notice.*

This equipment has been tested and found to comply with the limits for a Class B digital device, pursuant to Part 15 of the FCC Rules. These limits are designed to provide reasonable protection against harmful interference in a residential installation. This equipment generates, uses, and can radiate radio frequency energy and, if not installed and used in accordance with the instructions, may cause harmful interference to radio communications. However, there is no guarantee that interference will not occur in a particular installation. If this equipment does cause harmful interference to radio or television reception, which can be determined by turning the equipment off and on, the user is encouraged to try to correct the interference by one or more of the following measures:

Reorient or relocate the receiving antenna.

Increase the separation between the equipment and receiver.

Connect the equipment into an outlet on a circuit different from that to which the receiver is connected.

Consult the dealer or an experienced radio/TV technician for help.

HOW TO LOCATE YOUR JVC SERVICE CENTER**TOLL FREE: 1-800-252-5722****<http://www.jvcservice.com>****Dear customer:**

In order to receive the most satisfaction from your purchase, read the instruction booklet before operating the unit. In the event that repair is necessary, or for the address nearest your location, please refer to the factory service center list below or within the Continental United States, call 1-800-252-5722 for your authorized servicer. Remember to retain your Bill of Sale for Warranty Service.

— JVC

**JVC SERVICE & ENGINEERING
COMPANY OF AMERICA
DIVISION OF JVC AMERICAS CORP.**

FACTORY SERVICE CENTER LOCATIONS

10 New Maple Avenue
Pine Brook, NJ 07058-9641
(973) 396-1000

1500 Lakes Parkway
Lawrenceville, GA 30243-5857
(770) 339-2522

705 Enterprise Street
Aurora, IL 60504-8135
(630) 851-7855

5665 Corporate Avenue
Cypress, CA 90630-4727
(714) 229-8011

10700 Hammerly Boulevard, Suite 110
Houston, TX 77043-2310
(713) 935-9331

2969 Mapunapuna Place, Suite 105
Honolulu, HI 96819-2000
(808) 833-5828

13 Cummings Park
Woburn, MA 01801-2105
(781) 376-9100

8192 W State Road 84
Davie, FL 33324-4611
(954) 472-1960

890 Dubuque Avenue
South San Francisco, CA 94080-1804
(650) 871-2666

Sophisticated electronic products may require occasional service. Just as quality is a keyword in the engineering and production of the wide array of JVC products, service is the key to maintaining the high level performance for which JVC is world famous. The JVC service and engineering organization stands behind our products.

NATIONAL HEADQUARTERS
JVC SERVICE & ENGINEERING COMPANY OF AMERICA
DIVISION OF JVC AMERICAS CORP.
10 New Maple Avenue
Pine Brook, NJ 07058-9641

If you ship the product...

Pack your JVC unit in the original carton or one of equivalent size and strength. Enclose, with the unit, a letter stating the problem or symptom that exists and also a copy of the receipt or bill of sale you received when you purchased your JVC unit. Print your home return address on the outside and the inside of the carton. Send to the appropriate JVC Factory Service Center as listed above.

Don't service it yourself.**CAUTION**

*To prevent electrical shock, do not open the cabinet. No user serviceable parts inside.
Refer servicing to qualified service personnel.*

ACCESSORIES

*To purchase accessories for your JVC product, you may contact your local JVC Dealer.
Or from the 48 Continental United States call toll free:
1-800-882-2345.*

LIMITED WARRANTY

CONSUMER VIDEO 1-90

JVC COMPANY OF AMERICA warrants this product and all parts thereof, except as set forth below ONLY TO THE ORIGINAL PURCHASER AT RETAIL to be FREE FROM DEFECTIVE MATERIALS AND WORKMANSHIP from the date of original retail purchase for the period as shown below. ("The Warranty Period")

PARTS	1 YR	LABOR	90 DAYS
-------	-------------	-------	----------------

THIS LIMITED WARRANTY IS VALID ONLY IN THE FIFTY (50) UNITED STATES, THE DISTRICT OF COLUMBIA AND IN COMMONWEALTH OF PUERTO RICO.

WHAT WE WILL DO:

If this product is found to be defective, JVC will repair or replace defective parts at no charge to the original owner. Such repair and replacement services shall be rendered by JVC during normal business hours at JVC authorized service centers. Parts used for replacement are warranted only for the remainder of the Warranty Period. All products and parts thereof may be brought to a JVC authorized service center on a carry-in basis except for Television sets having a screen size 25 inches and above which are covered on an in-home basis.

WHAT YOU MUST DO FOR WARRANTY SERVICE:

Return your product to a JVC authorized service center with a copy of your bill of sale. For your nearest JVC authorized service center, please call toll free: (800) 252-5722.

If service is not available locally, box the product carefully, preferably in the original carton, and ship, insured, with a copy of your bill of sale plus a letter of explanation of the problem to the nearest JVC Factory Service Center, the name and location of which will be given to you by the toll-free number.

If you have any questions concerning your JVC Product, please contact our Customer Relations Department.

WHAT IS NOT COVERED:

This limited warranty provided by JVC does not cover:

1. Products which have been subject to abuse, accident, alteration, modification, tampering, negligence, misuse, faulty installation, lack of reasonable care, or if repaired or serviced by anyone other than a service facility authorized by JVC to render such service, or if affixed to any attachment not provided with the products, or if the model or serial number has been altered, tampered with, defaced or removed;
2. Initial installation and installation and removal for repair;
3. Operational adjustments covered in the Owner's Manual, normal maintenance, video and audio head cleaning;
4. Damage that occurs in shipment, due to act of God, and cosmetic damage;
5. Signal reception problems and failures due to line power surge;
6. Video Pick-up Tubes/CCD Image Sensor, Cartridge, Stylus (Needle) are covered for 90 days from the date of purchase;
7. Accessories;
8. Batteries (except that Rechargeable Batteries are covered for 90 days from the date of purchase); from the date of purchase);

There are no other express warranties except as listed above.

THE DURATION OF ANY IMPLIED WARRANTIES INCLUDING THE IMPLIED WARRANTY OF MERCHANTABILITY, IS LIMITED TO THE DURATION OF THE EXPRESS WARRANTY HEREIN.

JVC SHALL NOT BE LIABLE FOR THE LOSS OF USE OF THE PRODUCT, INCONVENIENCE, LOSS OR ANY OTHER DAMAGES, WHETHER DIRECT, INCIDENTAL OR CONSEQUENTIAL (INCLUDING, WITHOUT LIMITATION, DAMAGE TO TAPES, RECORDS OR DISCS) RESULTING FROM THE USE OF THIS PRODUCT, OR ARISING OUT OF ANY BREACH OF THIS WARRANTY. ALL EXPRESS AND IMPLIED WARRANTIES, INCLUDING THE WARRANTIES OF MERCHANTABILITY AND FITNESS FOR PARTICULAR PURPOSE, ARE LIMITED TO THE WARRANTY PERIOD SET FORTH ABOVE.

Some states do not allow the exclusion of incidental or consequential damages or limitations on how long an implied warranty lasts, so these limitations or exclusions may not apply to you. This warranty gives you specific legal rights and you may also have other rights which vary from state to state.

JVC COMPANY OF AMERICA
DIVISION OF JVC AMERICAS CORP.

1700 Valley Road
Wayne, New Jersey 07470

REFURBISHED PRODUCTS CARRY A SEPARATE WARRANTY, THIS WARRANTY DOES NOT APPLY. FOR DETAILS OF REFURBISHED PRODUCT WARRANTY, PLEASE REFER TO THE REFURBISHED PRODUCT WARRANTY INFORMATION PACKAGED WITH EACH REFURBISHED PRODUCT.

For customer use:

Enter below the Model No. and Serial No. which is located either on the rear, bottom or side of the cabinet. Retain this information for future reference.

Model No.: _____

Serial No.: _____

Purchase date: _____

Name of dealer: _____

JVC

VICTOR COMPANY OF JAPAN, LIMITED